

**ATX Mid Tower PC Case**

**ZALMAN**  
COOL INNOVATIONS

# Z3 SERIES

English / 한 글 / Français / Español

**Z3**

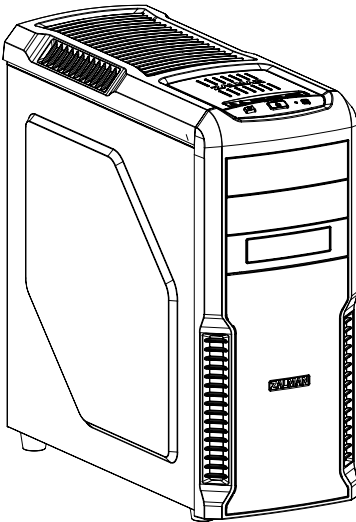

**Z3 Plus**

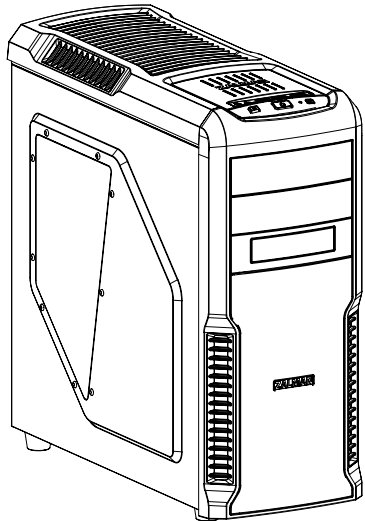

# ENGLISH / 한 글

## 1. Cautionary Note

1. Please read this manual thoroughly prior to installation.
2. Before installing, check the components and condition of the product, and if any problem is found, contact the retailer.
3. Please wear gloves while handling this product to prevent injuries.
4. Incorrect cable connections may cause short circuits leading to fire hazards.
5. Do not block the front intake vent or the rear exhaust vent.
6. Keep this unit away from heat sources, direct sunlight, water, oil and place the unit on a flat and well-ventilated area.
7. Do not clean the product surface with chemicals or wet cloth.  
(chemicals: industrial alcohol, paint thinner and organic solvent etc.)
8. Avoid inserting objects or hands into the system while it is in operation to prevent product damage and injuries.
9. Zalman Tech Co., Ltd. is not responsible for any improper use.
10. Product design and specifications may be revised to improve quality and performance.

## 1. 주의사항

1. 설치 전 설명서를 숙독하십시오.
2. 설치 전 제품과 구성품을 반드시 확인 후 이상이 있을 경우 구입처에 교환/환불 조치 받으십시오.
3. 제품 설치 시 사고 예방을 위해 장갑을 착용하고 취급하십시오.
4. 시스템 장착 시 치명적 손상이 발생할 수 있으므로 무리한 힘을 가하지 마십시오.
5. 케이블을 잘못 연결하면 합선으로 인한 화재 우려가 있어 필히 설명서를 참고하여 연결하십시오.
6. 시스템 사용시 제품의 통풍구가 막히지 않도록 주의하십시오.
7. 직사광선, 물, 습기, 기름, 먼지가 많은 곳을 피하고 공기가 잘 통하는 곳에서 보관/사용하십시오.
8. 화학약품 등으로 제품의 표면을 닦지 마십시오. (알코올 또는 아세톤 등 유기용제)
9. 동작 중에는 인체나 제품에 해를 끼칠 수 있으므로 손이나 물체를 넣지 마십시오.
10. 어린이의 손이 닿지 않는 곳에서 보관/사용하십시오.
11. 정해진 용도 외의 사용 및 소비자 부주의로 발생한 문제는 당사에서 책임지지 않습니다.
12. 제품의 외관 디자인 및 규격은 품질 향상을 위해 소비자에게 예고 없이 변경될 수 있습니다.

## 4. Components / 구성품

### Components / 공용구성품



A Bolt  
(#6-32\*5mm) x 13  
[PSU,PCI]



B Bolt  
(M3\*5mm) x 25  
[M/B,FDD,SSD,ODD]



C Bolt  
(FAN) x 4  
(BH M3\*28mm)



D Bolt  
(FAN) x 2  
(FH Tap5\*10mm)



Stand Off x 6

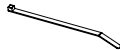

Cable Tie x 5



HDD Guide



Manual x 1

### Z3 Plus Components / Z3 Plus 구성품



VGA Guide x 1



Guide Clip x 2

## 5. Front I/O Ports / 상면 I/O 포트

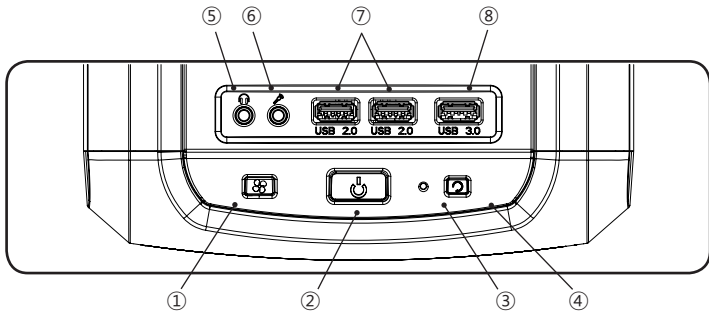

#	Part / 명칭	#	Part / 명칭
①	FAN Controller / 팬 컨트롤러	②	Power Button / 전원
③	HDD LED	④	Reset Button / 리셋버튼
⑤	Headphones / 헤드폰	⑥	Mic / 마이크
⑦	USB 2.0	⑧	USB 3.0

### Fan Cotroller

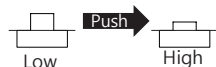
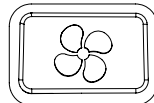

6. Installation / 설치방법

1) Side Panel Removal / 사이드 커버 분리

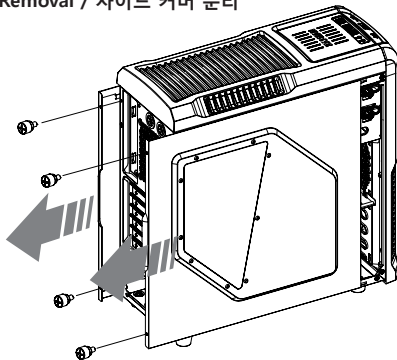

2) Motherboard Installation / 마더보드 설치

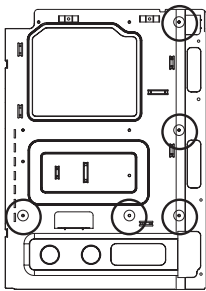

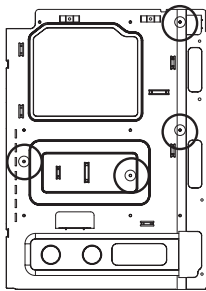

ATX



M-ATX

- There are 6 Stand-offs preinstalled. Please refer to the diagrams below for additional Stand Off positions (based on motherboard type).

- 기본 6개의 Stand-Off가 장착되어 있으며, 하단 그림을 참조하여 마더보드 타입에 따라 Stand-Off를 추가로 끼우고 마더보드를 케이스에 장착합니다.

	Stand-Off
	B Bolt

3) VGA Card Installation / 그래픽 카드 설치

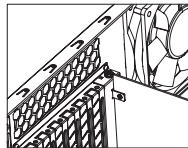
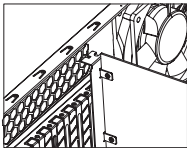
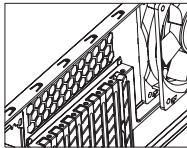

	A Bolt
---	--------

- ① Unfasten the Hand Screw holding the PCI Cover and disassemble the cover.
- ② Remove the PCI Slot Cover.
- ③ Install the VGA Card and fasten with a fixing screw.

- ① PCI커버를 고정하는 핸드 스크류를 풀고 커버를 분리합니다.
- ② PCI 커버를 제거합니다.
- ③ 그래픽 카드를 설치하고 고정나사로 고정합니다.

※ Tip / 추가사항

1. The VGA Support system is designed to support the weight of high profile video cards to prevent warping.  
1. 그래픽 카드의 처짐을 방지하기 위해서 그래픽 카드 지지대를 설치하여 처짐을 방지할 수 있습니다.

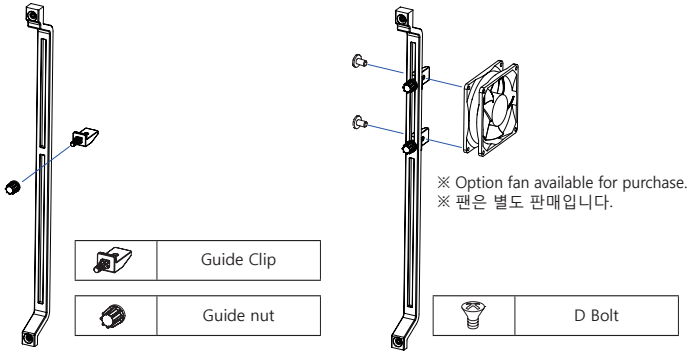

- Assemble the clip and the nut as shown.  
- 그림과 같이 클립과 너트를 조립합니다.

- Install the Fan on the assemble clip as shown.  
- 그림과 같이 조립한 클립에 팬을 조립합니다.

4) 5.25" and 3.5" Drive Installation / 5.25" 및 3.5" 드라이브 설치

- 1) Front Cover removal / Front Cover 분리

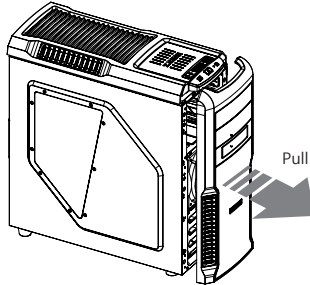

- 2) ODD Installation / ODD 설치

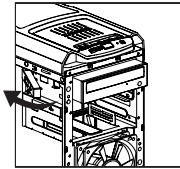

- 3) 3.5 Installation / 외부 3.5" 장착

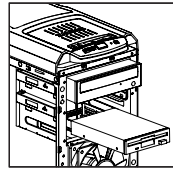
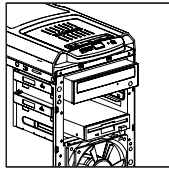

### 5) 3.5" HDD Installation / 3.5" HDD 장착

- Use the HDD Guide to install 3.5" HDD.
- HDD GUIDE를 이용하여 3.5" HDD를 장착합니다.

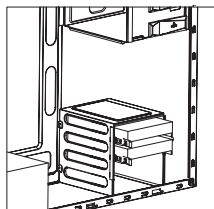
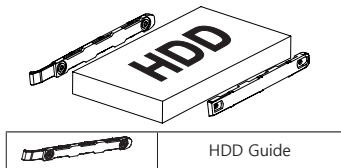

### 6) Cable Connection / 케이블 연결

Power Button / 전원 버튼

Fan Controller Connection / Fan Controller 연결

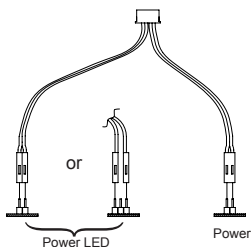

Motherboard / 마더보드

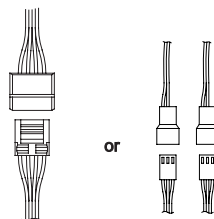

PSU Power / PSU 전원

Fan Power / Fan 전원

I/O Port

Audio



HD Audio



Reset



HDD LED

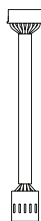

USB 2.0

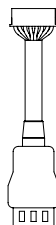

USB 3.0

Mother Board

Mother Board I/O

### 7) 2.5" HDD and SSD Optional / 2.5" HDD/SSD 추가 장착

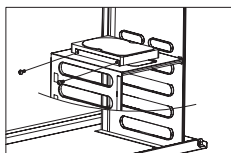

B Bolt

- 2.5" HDD and SSDs can be installed on the right side of case as shown in the diagram below.

- 다음 그림과 같이 케이스 오른쪽 측면에 SSD를 장착하여 사용할 수 있습니다.

## 7. 품질보증 및 A/S 안내

1. 제품 보증기간: 제품 구입일로부터 1년(단, 구입 영수증이 있을 때)
2. 무상A/S: 품질 보증기간 내에 제품 자체 성능상의 하자 및 불량 발생시
3. 유상A/S: 품질 보증기간 이후에 제품 사용상의 문제 발생시. 단, 아래와 같은 사항에 대해서는 품질 보증기간 이내라도 무상A/S 처리가 되지 않으며 소비자 부담으로 처리됩니다.
  - ☞ 본 사용 설명서에 명시된 설치 전 주의사항 및 유의사항을 지키지 않은 경우
  - ☞ 사용자의 고의나 과실 및 부주의로 인하여 변형/파손/파괴된 경우
  - ☞ 사용자의 임의 개조에 의한 변형 및 고장이 발생한 경우
4. 교환 및 환불
  - 1) 교환: 제품 구입일로부터 1개월 이내에 제품 자체 성능상의 하자 또는 불량 발생시 동일 제품으로 교환하여 드립니다.
  - 2) 환불: 제품 구입 후 10일 이내에 제품 및 포장의 훼손이 없는 경우에만 구입처를 통해 환불 받으실 수 있습니다. (단, 제품 구입시 발급해 드린 영수증을 제시하셔야 환불 가능합니다)
5. A/S
  - 1) 운영시간: 평일 09:00~18:00 (공휴일, 토요일 휴무)
  - 2) 접수 방법
    - ① 방문 접수: 직접 방문할 경우 사전 연락 후 방문해 주시기 바랍니다.
    - ② 택배 접수: 택배(우편)를 이용하실 경우 아래의 주소로 성함, 주소, 연락처 및 불량 상태를 적은 메모지를 넣어서 보내주시시오.
  - 3) 접수처
    - ◆ 총판 (아이구주): 서울시 용산구 한강로2가 16-1선인상가 21동 3층 126-128호 ☎070-8250-1428
6. 제품 운송비용
  - 1) 무상A/S의 경우: 전액 당사가 부담합니다.
  - 2) 유상A/S의 경우: 당사로 보내시는 비용은 고객이 부담하시고, A/S처리 후 발송하는 비용은 당사가 부담합니다.
  - 3) 보증기간 이후: 전액 고객 부담입니다.

# Français / Español

## 1. Précautions

1. Assurez-vous d'être bien informé du manuel du produit avant son installation.
2. Assurez-vous de vérifier l'état des composants et des produits, et s'il vous plaît consulter votre revendeur quand il y a une erreur.
3. Assurez-vous de porter des gants pour éviter les blessures ou les accidents lors de la manipulation de ce produit.
4. il y a un risque d'incendie dû à un court-circuit si vous les connectez incorrectement.
5. Veillez à ne pas bloquer les aérations à l'avant et à l'arrière du produit.
6. Installez le produit dans des endroits aérés, plats, et exempt de vibrations sans lumière solaire directe, chaleur générée par le chauffage, éclaboussures d'eau (pluie), ou beaucoup d'humidité et d'huile.
7. Ne pas nettoyer le produit avec des produits chimiques (produits chimiques, cirages industrielles, alcool, dissolvant, lubrifiant, détergent etc.)
8. Ne pas mettre la main ou des objets dans le produit actif. Cela peut nuire au corps humain et au produit.
9. Nous ne prenons aucune responsabilité pour les problèmes qui se produisent en raison d'une utilisation autre que l'usage prévu
10. La conception ou les spécifications sont sujettes à modification sans préavis aux clients afin d'améliorer la qualité du produit.

## 1. Precauciones

1. Antes de instalar, leer rápidamente las instrucciones del producto.
2. Antes de instalar, verificar el estado del producto y los componentes y en caso de que haya anomalías consulte con el departamento de compras.
3. Para prevención de accidentes y heridas durante el manejo de este producto, usar guantes de seguridad
4. Al conectar los cables, conecte los cables después de verificar el manual. En caso de mala conexión hay peligro de fuego por corto circuito.
5. Precaución en que el ventilador de la parte frontal y trasera del producto no este obstruido.
6. Evitar lugares que hay calor como lugares con rayo de sol directo o alrededor de calefacciones, lugares que salpica agua (lluvia), lugares con mucho aceite o humedad e instalar en lugares que conduzca mucho aire, plano y que no haya vibraciones.
7. No limpiar la superficie del producto con medicamentos químicos. (Medicamentos químicos, barniz industrial, cera, benceno, alcohol, diluyente, medicamento para lubricante etc.)
8. No introducir las manos u objetos en los productos en movimiento. Puede causarnos al producto o al cuerpo.
9. La compañía no será responsable sobre los problemas ocurridos por el uso además del uso determinado
10. El diseño exterior y el modelo del producto puede ser cambiado sin aviso previo al consumidor para el mejoramiento de calidad del producto.



## 4. Partes / Components

### Partes / Common Components



Vis A / Tornillo A  
(#6-32\*5mm) x 13  
[PSU,PCI]



Vis B / Tornillo B  
(M3\*5mm) x 25  
[M/B,FDD,SSD,ODD]



Vis C / Tornillo C  
(FAN) x 4  
(BH M3\*28mm)



Vis D / Tornillo D  
(FAN) x 2  
(FH Tap5\*10mm)



Ecrou / Soporte  
x 6

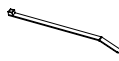

Attache de câble /  
Sujetacable x 5



Guide Pour disque dur  
Guía del HDD



Instructions / Manual  
x 1

### Z3 Plus Partes / Z3 Plus Components



Guide VGA / Guía VGA  
x 1



Clip de Guide / Clip de Guía  
x 2

## 5. Top IO ports / Puerto de IO en superficie

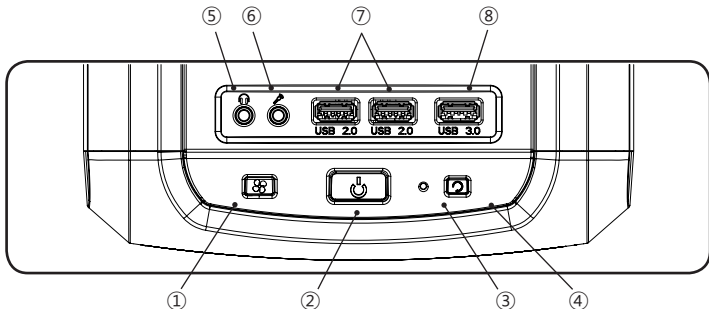

#	Part Name	#	Part Name
①	Contrôleur de ventilateur / Control de Abanico	②	Bouton d'alimentation / Botón de Potencia
③	LED de HDD / LED HDD	④	Bouton de réinitialisation / Botón de Reinicio
⑤	Casque / Audífonos	⑥	Mic
⑦	USB 2.0	⑧	USB 3.0

### Contrôleur de ventilateur / Control de Abanico

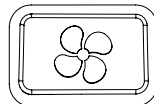

## 6. Installation

### 1) Retrait du panneau latéral / Retirar el panel lateral

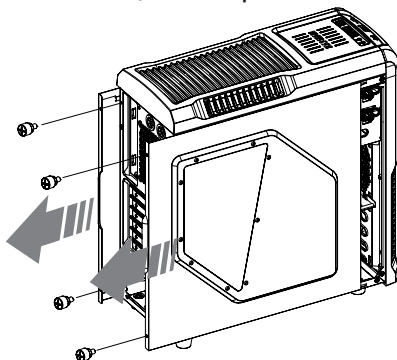

### 2) Installation de la carte mère / Instalación de la placa base

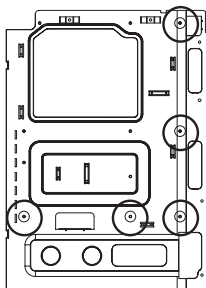

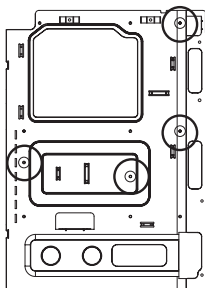

ATX



M-ATX

- Six vis sont pré installées.  
En fonction de votre carte mère, référez vous aux diagrammes ci-dessous pour installer les vis.

- Seis tornillos están pre instalados. Dependiendo de la placa base, para instalar los tornillos consulte los diagramas a continuación.

	Ecrou
	Vis B / Tornillo B

### 3) Assemblage de la carte graphique / Ensamblaje de tarjeta grafica

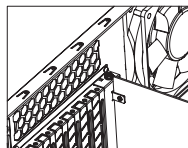
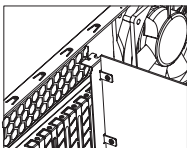
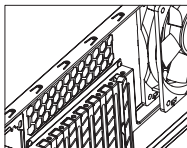

Vis A / Tornillo A

- ① Desserrer la vis à la main qui fixe le couvercle de PCI et séparer le couvercle.
  - ② Retirer le couvercle du logement PCI.
  - ③ Installer la carte graphique et la fixer avec vis de fixation.
- ① Separar el cubierto desarmando el tornillo de mano que fija el cubierto PCI.
  - ② Remover el cubierto de la ranura PCI.
  - ③ Instalar la tarjeta grafica y fijar con tornillo.

※ **Installation de la carte graphique / Asuntos Adicionales**

1. En installant le guide VGA, vous pouvez empêcher la carte graphique de s'affaisser.  
1. Para prevenir la suspensión de la tarjeta grafica, instale el sostén VGA y puede prevenir la suspensión.

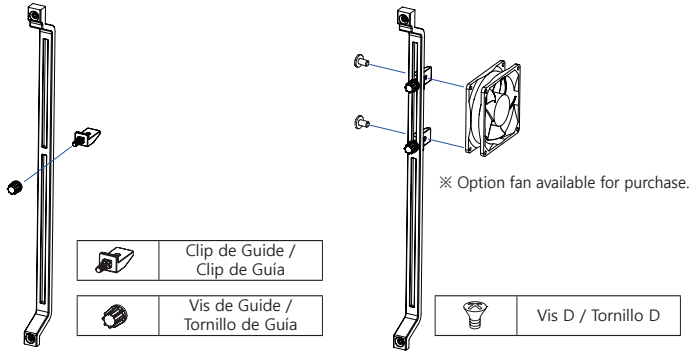

- Assembler des clips et des écrous comme indiqué sur la figure.  
- Ensamblar el clip y la tuerca según la imagen
- Combiner le ventilateur avec les clips assemblés comme indiqué sur la figure.  
- Ensamblar el abanico en el clip que armo según la imagen.

**4) Installation des lecteurs de 5.25" et 3.5" / Instalación de unidades de 5.25" y 3.5"**

- 1) Séparation de couvercle avant / Remove tapa frontal

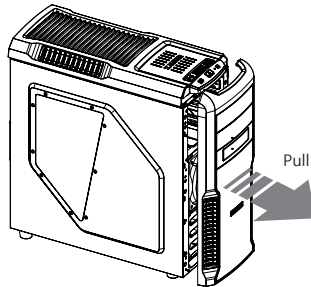

- 2) Installation de l'ODD  
2) Instalar ODD

- 3) Installation des plateaux de 2.5" et 3.5"  
3) Instalación de bandejas de 5.25" / 3.5"

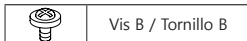
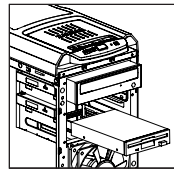
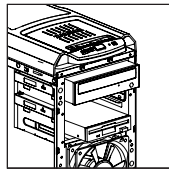
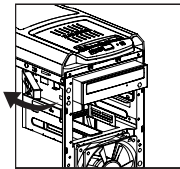

### 5) Montage de HDD de 3.5"

- Use the HDD Guide to install 3.5" HDD.
- Ver la guía del HDD para la instalación.

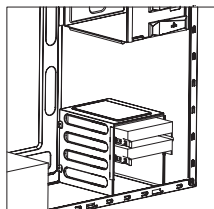
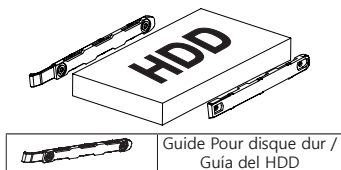

### 6) onnexion des câbles / Cable Connection

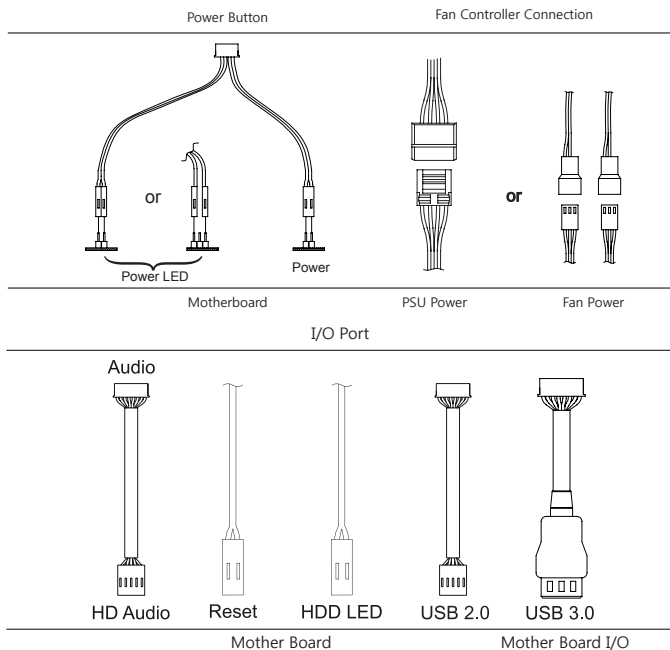

### 7) Disques dur 2.5" HDD & SSD optionnels / 2.5" HDD & SSD Opcional

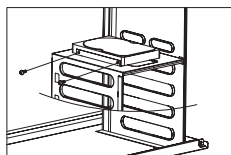

- Les disques durs ou SSD 2.5" peuvent étres installés sur le côté droit du châssis comme montré ci-dessous.
- Discos duros (HDD) y de estado sólido (SSD) de 2.5" pueden ser instalados en el lado derecho de la caja tal como se muestra en el diagrama debajo.