

# **GA-Z87-HD3**

# **GA-H87-HD3**

## **User's Manual**

Rev. 1002

12ME-Z87HD3-1002R

## Declaration of Conformity

We, Manufacturer/Importer,

G.B.T. Technology Trading GmbH  
Bullenkoppel 16, 22047 Hamburg, Germany

Address:

Declare that the product

Product Type: **Motherboard**  
Product Name: **GA-Z87-HD3/GA-H87-HD3**

conforms with the essential requirements of the following directives:

- 2004/108/EC EMC Directive:**
  - Conduction & Radiated Emissions: EN55022:2006+A1:2007
  - Immunity: EN55024:1988+A1:2001+A2:2003
  - Power-line harmonics: EN61000-3-2:2006
  - Power-line flicker: EN61000-3-3:2008

- 2006/95/EC LVD Directive**
  - Safety: EN60950-1:2006+A11:2009

- 2011/65/EU RoHS Directive**
  - Restriction of use of certain substances in electronic equipment: This product does not contain any of the restricted substances listed in Annex II, in concentrations and applications banned by the directive.

**CE marking**

  
(EC conformity marking)

(Stamp)

Date: Apr. 19, 2013

Name:

Timmy Huang

Signature:



## DECLARATION OF CONFORMITY

Per FCC Part 2 Section 2.1077(a)



Responsible Party Name: **G.B.T. INC. (U.S.A)**

Address: **17358 Railroad Street**

City of Industry, CA 91748

Phone/Fax No: (626) 854-9338/ (626) 854-9326

hereby declares that the product

**Product Name: Motherboard**

**Model Number: GA-Z87-HD3/GA-H87-HD3**

Conforms to the following specifications:

FCC Part 15, Subpart B, Section 15.107(a) and Section 15.109

(a), Class B Digital Device

### Supplementary Information:

This device complies with part 15 of the FCC Rules. Operation is subject to the following two conditions: (1) This device may not cause harmful and (2) this device must accept any interference received, including that may cause undesired operation.

Representative Person's Name: **ERIC LU**

Signature: 

Date: APR. 19, 2013

## **Copyright**

© 2013 GIGA-BYTE TECHNOLOGY CO., LTD. All rights reserved.

The trademarks mentioned in this manual are legally registered to their respective owners.

## **Disclaimer**

Information in this manual is protected by copyright laws and is the property of GIGABYTE. Changes to the specifications and features in this manual may be made by GIGABYTE without prior notice.

No part of this manual may be reproduced, copied, translated, transmitted, or published in any form or by any means without GIGABYTE's prior written permission.

## **Documentation Classifications**

In order to assist in the use of this product, GIGABYTE provides the following types of documentations:

- For quick set-up of the product, read the Quick Installation Guide included with the product.
- For detailed product information, carefully read the User's Manual.

For product-related information, check on our website at: <http://www.gigabyte.com>

## **Identifying Your Motherboard Revision**

The revision number on your motherboard looks like this: "REV: X.X." For example, "REV: 1.0" means the revision of the motherboard is 1.0. Check your motherboard revision before updating motherboard BIOS, drivers, or when looking for technical information.

Example:

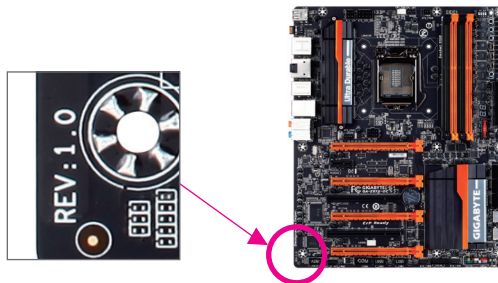

# Table of Contents

Box Contents .....	6
Optional Items .....	6
GA-Z87-HD3/GA-H87-HD3 Motherboard Layout .....	7
GA-Z87-HD3/GA-H87-HD3 Motherboard Block Diagram.....	8
Chapter 1 Hardware Installation .....	9
1-1 Installation Precautions .....	9
1-2 Product Specifications .....	10
1-3 Installing the CPU and CPU Cooler.....	13
1-3-1 Installing the CPU .....	13
1-3-2 Installing the CPU Cooler .....	15
1-4 Installing the Memory .....	16
1-4-1 Dual Channel Memory Configuration .....	16
1-4-2 Installing a Memory.....	17
1-5 Installing an Expansion Card.....	18
1-6 Back Panel Connectors .....	19
1-7 Internal Connectors .....	21
Chapter 2 BIOS Setup .....	31
2-1 Startup Screen.....	32
2-2 The Main Menu .....	33
2-3 M.I.T. ....	35
2-4 System .....	45
2-5 BIOS Features .....	46
2-6 Peripherals.....	50
2-7 Power Management.....	54
2-8 Save & Exit .....	56



Chapter 3	Configuring SATA Hard Drive(s)	57
3-1	Configuring SATA Controllers	57
3-2	Installing the SATA RAID/AHCI Driver and Operating System	69
Chapter 4	Drivers Installation	73
4-1	Chipset Drivers	73
4-2	Application Software	74
4-3	Information	74
Chapter 5	Unique Features	75
5-1	BIOS Update Utilities	75
5-1-1	Updating the BIOS with the Q-Flash Utility	75
5-1-2	Updating the BIOS with the @BIOS Utility	78
5-2	APP Center	79
5-2-1	EasyTune	80
5-2-2	EZ Setup	81
5-2-3	USB Blocker	86
Chapter 6	Appendix	87
6-1	Configuring Audio Input and Output	87
6-1-1	Configuring 2/4/5.1/7.1-Channel Audio	87
6-1-2	Configuring S/PDIF Out	89
6-1-3	Configuring Microphone Recording	89
6-1-4	Using the Sound Recorder	92
6-2	Troubleshooting	93
6-2-1	Frequently Asked Questions	93
6-2-2	Troubleshooting Procedure	94
	Regulatory Statements	96
	Contact Us	99

## Box Contents

- GA-Z87-HD3 or GA-H87-HD3 motherboard
- Motherboard driver disk
- User's Manual
- Quick Installation Guide
- Four SATA cables
- I/O Shield

The box contents above are for reference only and the actual items shall depend on the product package you obtain. The box contents are subject to change without notice.

## Optional Items

- 2-port USB 2.0 bracket (Part No. 12CR1-1UB030-6\*R)
- eSATA bracket (Part No. 12CF1-3SATPW-4\*R)
- 3.5" Front Panel with 2 USB 3.0/2.0 ports (Part No. 12CR1-FPX582-2\*R)
- S/PDIF In cable (Part No. 12CR1-1SPDIN-1\*R)
- HDMI-to-DVI adapter (Part No. 12CT2-HDMI01-1\*R)
- LPT port cable (Part No. 12CF1-1LP001-0\*R)
- COM port cable (Part No. 12CF1-1CM001-3\*R)

# GA-Z87-HD3/GA-H87-HD3 Motherboard Layout

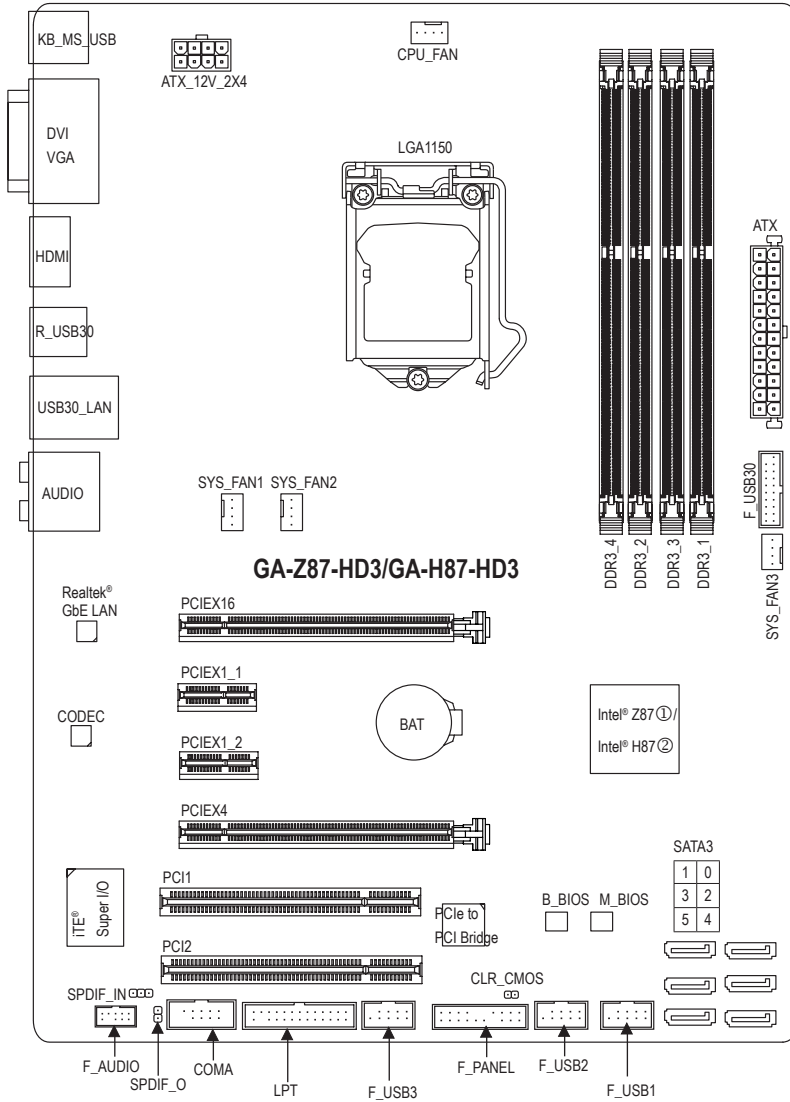

- ① Only for GA-Z87-HD3.
- ② Only for GA-H87-HD3.

# GA-Z87-HD3/GA-H87-HD3 Motherboard Block Diagram

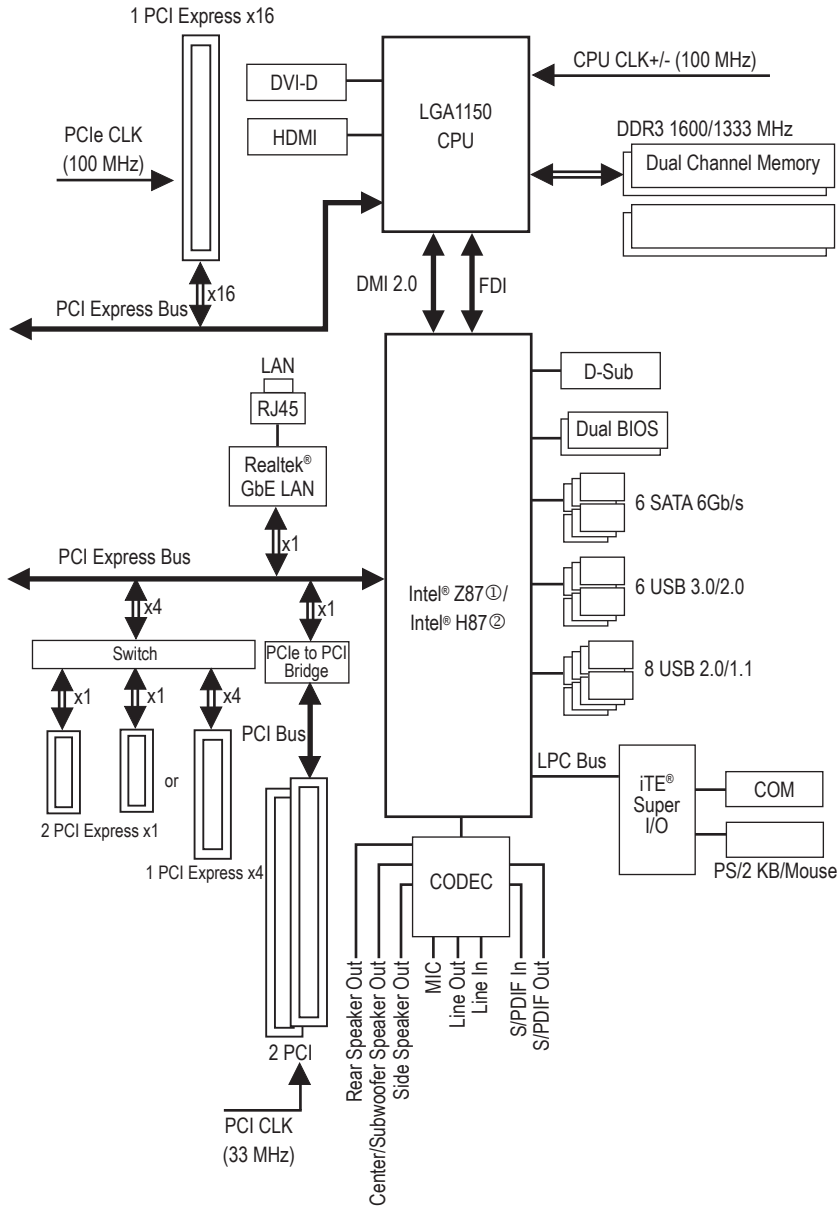

① Only for GA-Z87-HD3.

② Only for GA-H87-HD3.



For detailed product information/limitation(s), refer to "1-2 Product Specifications."









# Chapter 1 Hardware Installation

## 1-1 Installation Precautions

The motherboard contains numerous delicate electronic circuits and components which can become damaged as a result of electrostatic discharge (ESD). Prior to installation, carefully read the user's manual and follow these procedures:







- Prior to installation, make sure the chassis is suitable for the motherboard.
- Prior to installation, do not remove or break motherboard S/N (Serial Number) sticker or warranty sticker provided by your dealer. These stickers are required for warranty validation.
- Always remove the AC power by unplugging the power cord from the power outlet before installing or removing the motherboard or other hardware components.
- When connecting hardware components to the internal connectors on the motherboard, make sure they are connected tightly and securely.
- When handling the motherboard, avoid touching any metal leads or connectors.
- It is best to wear an electrostatic discharge (ESD) wrist strap when handling electronic components such as a motherboard, CPU or memory. If you do not have an ESD wrist strap, keep your hands dry and first touch a metal object to eliminate static electricity.
- Prior to installing the motherboard, please have it on top of an antistatic pad or within an electrostatic shielding container.
- Before unplugging the power supply cable from the motherboard, make sure the power supply has been turned off.
- Before turning on the power, make sure the power supply voltage has been set according to the local voltage standard.
- Before using the product, please verify that all cables and power connectors of your hardware components are connected.
- To prevent damage to the motherboard, do not allow screws to come in contact with the motherboard circuit or its components.
- Make sure there are no leftover screws or metal components placed on the motherboard or within the computer casing.
- Do not place the computer system on an uneven surface.
- Do not place the computer system in a high-temperature environment.
- Turning on the computer power during the installation process can lead to damage to system components as well as physical harm to the user.
- If you are uncertain about any installation steps or have a problem related to the use of the product, please consult a certified computer technician.





## 1-2 Product Specifications

	CPU	<ul style="list-style-type: none"> <li>◆ Support for Intel® Core™ i7 processors/Intel® Core™ i5 processors/Intel® Core™ i3 processors/Intel® Pentium® processors/Intel® Celeron® processors in the LGA1150 package (Go to GIGABYTE's website for the latest CPU support list.)</li> <li>◆ L3 cache varies with CPU</li> </ul>
	Chipset	<ul style="list-style-type: none"> <li>◆ Intel® Z87<sup>①</sup>/Intel® H87<sup>②</sup> Express Chipset</li> </ul>
	Memory	<ul style="list-style-type: none"> <li>◆ 4 x 1.5V DDR3 DIMM sockets supporting up to 32 GB of system memory <ul style="list-style-type: none"> <li>* Due to a Windows 32-bit operating system limitation, when more than 4 GB of physical memory is installed, the actual memory size displayed will be less than the size of the physical memory installed.</li> </ul> </li> <li>◆ Dual channel memory architecture</li> <li>◆ Support for DDR3 1600/1333 MHz memory modules</li> <li>◆ Support for non-ECC memory modules</li> <li>◆ Support for Extreme Memory Profile (XMP) memory modules (Go to GIGABYTE's website for the latest supported memory speeds and memory modules.)</li> </ul>
	Onboard Graphics	<ul style="list-style-type: none"> <li>◆ Integrated Graphics Processor: <ul style="list-style-type: none"> <li>- 1 x D-Sub port</li> <li>- 1 x DVI-D port, supporting a maximum resolution of 1920x1200 <ul style="list-style-type: none"> <li>* The DVI-D port does not support D-Sub connection by adapter.</li> </ul> </li> <li>- 1 x HDMI port, supporting a maximum resolution of 4096x2160 <ul style="list-style-type: none"> <li>* Support for HDMI 1.4a version.</li> </ul> </li> <li>- Maximum shared memory of 1 GB</li> </ul> </li> </ul>
	Audio	<ul style="list-style-type: none"> <li>◆ Realtek® ALC892 codec</li> <li>◆ High Definition Audio</li> <li>◆ 2/4/5.1/7.1-channel</li> <li>◆ Support for S/PDIF In</li> <li>◆ Support for S/PDIF Out</li> </ul>
	LAN	<ul style="list-style-type: none"> <li>◆ Realtek® GbE LAN chip (10/100/1000 Mbit)</li> </ul>
	Expansion Slots	<ul style="list-style-type: none"> <li>◆ 1 x PCI Express x16 slot, running at x16 (PCIEX16) (The PCIEX16 slot conforms to PCI Express 3.0 standard.) <ul style="list-style-type: none"> <li>* For optimum performance, if only one PCI Express graphics card is to be installed, be sure to install it in the PCIEX16 slot.</li> </ul> </li> <li>◆ 1 x PCI Express x16 slot, running at x4 (PCIEX4) <ul style="list-style-type: none"> <li>* The PCIEX4 slot shares bandwidth with all PCI Express x1 slots. All PCI Express x1 slots will become unavailable when a PCIe x4 expansion card is installed.</li> <li>* When installing a x8 or above card in the PCIEX4 slot, make sure to set PCIe Slot Configuration in BIOS Setup to x4.</li> </ul> </li> <li>◆ 2 x PCI Express x1 slots (The PCIEX4 and PCI Express x1 slots conform to PCI Express 2.0 standard.)</li> <li>◆ 2 x PCI slots</li> </ul>
	Multi-Graphics Technology	<ul style="list-style-type: none"> <li>◆ Support for AMD CrossFire™ technology <ul style="list-style-type: none"> <li>* The PCIEX16 slot operates at up to x4 mode when AMD CrossFire™ is enabled.</li> </ul> </li> </ul>

① Only for GA-Z87-HD3.

② Only for GA-H87-HD3.

	Storage Interface	<ul style="list-style-type: none"> <li>◆ Chipset: <ul style="list-style-type: none"> <li>- 6 x SATA 6Gb/s connectors supporting up to 6 SATA 6Gb/s devices</li> <li>- Support for RAID 0, RAID 1, RAID 5, and RAID 10</li> </ul> </li> </ul>
	USB	<ul style="list-style-type: none"> <li>◆ Chipset: <ul style="list-style-type: none"> <li>- Up to 6 USB 3.0/2.0 ports (4 ports on the back panel, 2 ports available through the internal USB header)</li> <li>- Up to 8 USB 2.0/1.1 ports (2 ports on the back panel, 6 ports available through the internal USB headers)</li> </ul> </li> </ul>
	Internal Connectors	<ul style="list-style-type: none"> <li>◆ 1 x 24-pin ATX main power connector</li> <li>◆ 1 x 8-pin ATX 12V power connector</li> <li>◆ 6 x SATA 6Gb/s connectors</li> <li>◆ 1 x CPU fan header</li> <li>◆ 3 x system fan headers</li> <li>◆ 1 x front panel header</li> <li>◆ 1 x front panel audio header</li> <li>◆ 1 x S/PDIF Out header</li> <li>◆ 1 x S/PDIF In header</li> <li>◆ 1 x USB 3.0/2.0 header</li> <li>◆ 3 x USB 2.0/1.1 headers</li> <li>◆ 1 x serial port header</li> <li>◆ 1 x parallel port header</li> <li>◆ 1 x Clear CMOS jumper</li> </ul>
	Back Panel Connectors	<ul style="list-style-type: none"> <li>◆ 1 x PS/2 keyboard/mouse port</li> <li>◆ 1 x D-Sub port</li> <li>◆ 1 x DVI-D port</li> <li>◆ 1 x HDMI port</li> <li>◆ 4 x USB 3.0/2.0 ports</li> <li>◆ 2 x USB 2.0/1.1 ports</li> <li>◆ 1 x RJ-45 port</li> <li>◆ 6 x audio jacks (Center/Subwoofer Speaker Out/Rear Speaker Out/Side Speaker Out/Line In/Line Out/Microphone)</li> </ul>
	I/O Controller	<ul style="list-style-type: none"> <li>◆ iTE® I/O Controller Chip</li> </ul>
	Hardware Monitor	<ul style="list-style-type: none"> <li>◆ System voltage detection</li> <li>◆ CPU/System temperature detection</li> <li>◆ CPU/System fan speed detection</li> <li>◆ CPU/System overheating warning</li> <li>◆ CPU/System fan fail warning</li> <li>◆ CPU/System fan speed control</li> </ul> <p style="margin-left: 40px;">* Whether the fan speed control function is supported will depend on the cooler you install.</p>

 BIOS	<ul style="list-style-type: none"> <li>◆ 2 x 64 Mbit flash</li> <li>◆ Use of licensed AMI EFI BIOS</li> <li>◆ Support for DualBIOS™</li> <li>◆ PnP 1.0a, DMI 2.0, SM BIOS 2.6, ACPI 2.0a</li> </ul>
 Unique Features	<ul style="list-style-type: none"> <li>◆ Support for Q-Flash</li> <li>◆ Support for Xpress Install</li> <li>◆ Support for APP Center <ul style="list-style-type: none"> <li>* Available applications in APP Center may differ by motherboard model. Supported functions of each application may also differ depending on motherboard specifications.</li> <li>- @BIOS</li> <li>- EasyTune</li> <li>- EZ Setup</li> <li>- USB Blocker</li> </ul> </li> <li>◆ Support for ON/OFF Charge</li> </ul>
 Bundled Software	<ul style="list-style-type: none"> <li>◆ Norton Internet Security (OEM version)</li> <li>◆ Intel® Rapid Start Technology</li> <li>◆ Intel® Smart Connect Technology</li> <li>◆ Intel® Smart Response Technology</li> <li>◆ Intel® Small Business Advantage<sup>®</sup></li> </ul>
 Operating System	<ul style="list-style-type: none"> <li>◆ Support for Windows 8/7</li> </ul>
 Form Factor	<ul style="list-style-type: none"> <li>◆ ATX Form Factor; 30.5cm x 22.5cm</li> </ul>

\* GIGABYTE reserves the right to make any changes to the product specifications and product-related information without prior notice.

\* Please visit the [Support & Downloads](#)Utility page on GIGABYTE's website to check the supported operating system(s) for the software listed in the "Unique Features" and "Bundled Software" columns.

Ⓜ Only for GA-H87-HD3.



## 1-3 Installing the CPU and CPU Cooler



Read the following guidelines before you begin to install the CPU:

- Make sure that the motherboard supports the CPU.  
(Go to GIGABYTE's website for the latest CPU support list.)
- Always turn off the computer and unplug the power cord from the power outlet before installing the CPU to prevent hardware damage.
- Locate the pin one of the CPU. The CPU cannot be inserted if oriented incorrectly. (Or you may locate the notches on both sides of the CPU and alignment keys on the CPU socket.)
- Apply an even and thin layer of thermal grease on the surface of the CPU.
- Do not turn on the computer if the CPU cooler is not installed, otherwise overheating and damage of the CPU may occur.
- Set the CPU host frequency in accordance with the CPU specifications. It is not recommended that the system bus frequency be set beyond hardware specifications since it does not meet the standard requirements for the peripherals. If you wish to set the frequency beyond the standard specifications, please do so according to your hardware specifications including the CPU, graphics card, memory, hard drive, etc.

### 1-3-1 Installing the CPU

A. Locate the alignment keys on the motherboard CPU socket and the notches on the CPU.

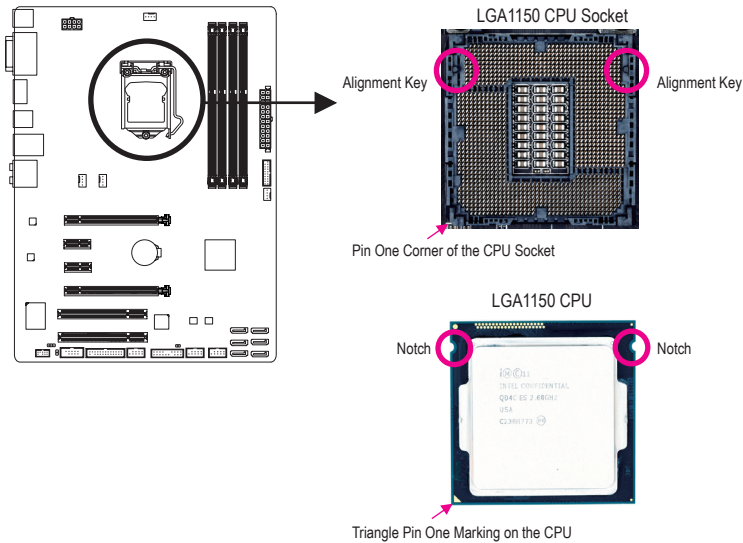

B. Follow the steps below to correctly install the CPU into the motherboard CPU socket.



- Before installing the CPU, make sure to turn off the computer and unplug the power cord from the power outlet to prevent damage to the CPU.
- To protect the socket contacts, do not remove the protective plastic cover unless the CPU is inserted into the CPU socket. Save the cover properly and replace it if the CPU is removed.

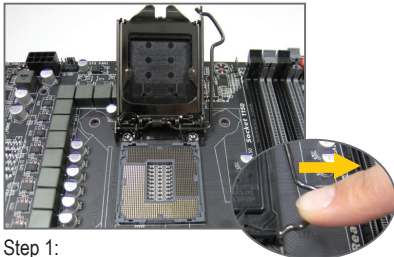

**Step 1:**  
Gently press the CPU socket lever handle down and away from the socket with your finger. Then completely lift the CPU socket lever and the metal load plate/plastic cover will be lifted as well.



**Step 2:**  
Hold the CPU with your thumb and index fingers. Align the CPU pin one marking (triangle) with the pin one corner of the CPU socket (or you may align the CPU notches with the socket alignment keys) and gently insert the CPU into position.

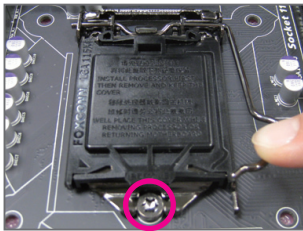

**Step 3:**  
Once the CPU is properly inserted, carefully replace the load plate. When replacing the load plate, make sure the front end of the load plate is under the shoulder screw. Then press the CPU socket lever. The protective plastic cover may pop off from the load plate during the process of engaging the lever. Remove the cover. (Save the cover properly and always replace it when the CPU is not installed.)



**Step 4:**  
Finally, secure the lever under its retention tab to complete the installation of the CPU.

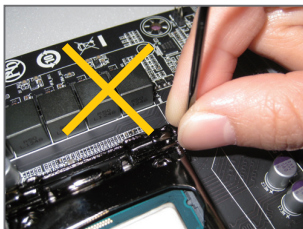

**NOTE:**

Hold the CPU socket lever by the handle, not the lever base portion.

### 1-3-2 Installing the CPU Cooler

Follow the steps below to correctly install the CPU cooler on the motherboard. (The following procedure uses Intel® boxed cooler as the example cooler.)



**Step 1:**  
Apply an even and thin layer of thermal grease on the surface of the installed CPU.

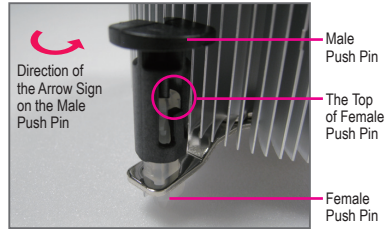

**Step 2:**  
Before installing the cooler, note the direction of the arrow sign ↻ on the male push pin. (Turning the push pin along the direction of arrow is to remove the cooler, on the contrary, is to install.)

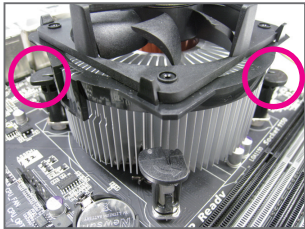

**Step 3:**  
Place the cooler atop the CPU, aligning the four push pins through the pin holes on the motherboard. Push down on the push pins diagonally.

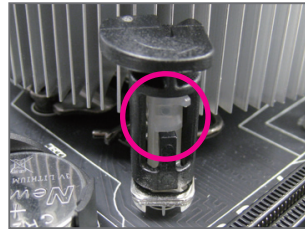

**Step 4:**  
You should hear a "click" when pushing down each push pin. Check that the Male and Female push pins are joined closely. (Refer to your CPU cooler installation manual for instructions on installing the cooler.)

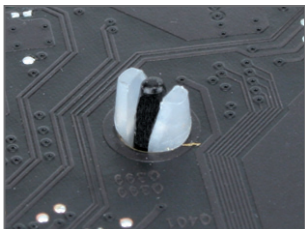

**Step 5:**  
After the installation, check the back of the motherboard. If the push pin is inserted as the picture above shows, the installation is complete.

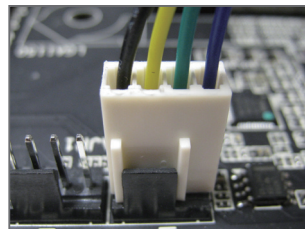

**Step 6:**  
Finally, attach the power connector of the CPU cooler to the CPU fan header (CPU\_FAN) on the motherboard.



Use extreme care when removing the CPU cooler because the thermal grease/tape between the CPU cooler and CPU may adhere to the CPU. Inadequately removing the CPU cooler may damage the CPU.

## 1-4 Installing the Memory



Read the following guidelines before you begin to install the memory:

- Make sure that the motherboard supports the memory. It is recommended that memory of the same capacity, brand, speed, and chips be used. (Go to GIGABYTE's website for the latest supported memory speeds and memory modules.)
- Always turn off the computer and unplug the power cord from the power outlet before installing the memory to prevent hardware damage.
- Memory modules have a foolproof design. A memory module can be installed in only one direction. If you are unable to insert the memory, switch the direction.

### 1-4-1 Dual Channel Memory Configuration

This motherboard provides four DDR3 memory sockets and supports Dual Channel Technology. After the memory is installed, the BIOS will automatically detect the specifications and capacity of the memory. Enabling Dual Channel memory mode will double the original memory bandwidth.

The four DDR3 memory sockets are divided into two channels and each channel has two memory sockets as following:

▶▶ Channel A: DDR3\_4, DDR3\_2

▶▶ Channel B: DDR3\_3, DDR3\_1

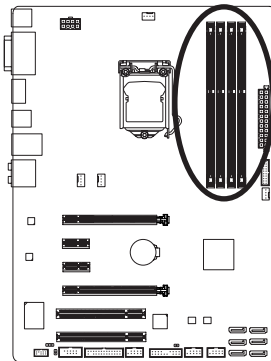

▶▶ Dual Channel Memory Configurations Table:

	DDR3_4	DDR3_2	DDR3_3	DDR3_1
Two Modules	--	DS/SS	--	DS/SS
	DS/SS	--	DS/SS	--
Four Modules	DS/SS	DS/SS	DS/SS	DS/SS

(SS=Single-Sided, DS=Double-Sided, "--"=No Memory)

Due to CPU limitations, read the following guidelines before installing the memory in Dual Channel mode.

1. Dual Channel mode cannot be enabled if only one DDR3 memory module is installed.
2. When enabling Dual Channel mode with two or four memory modules, it is recommended that memory of the same capacity, brand, speed, and chips be used and installed in the same colored DDR3 sockets. For optimum performance, when enabling Dual Channel mode with two memory modules, we recommend that you install them in the DDR3\_1 and DDR3\_2 sockets.

## 1-4-2 Installing a Memory

 Before installing a memory module, make sure to turn off the computer and unplug the power cord from the power outlet to prevent damage to the memory module. DDR3 and DDR2 DIMMs are not compatible to each other or DDR DIMMs. Be sure to install DDR3 DIMMs on this motherboard.

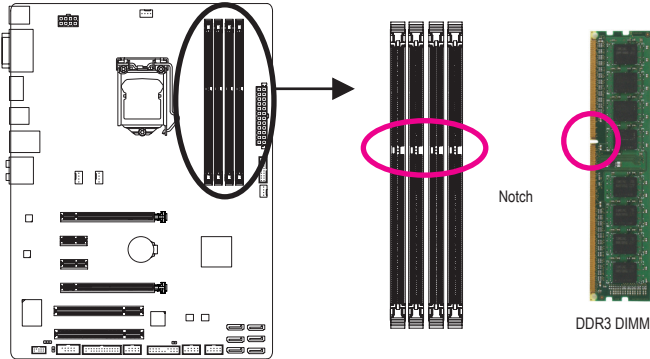

A DDR3 memory module has a notch, so it can only fit in one direction. Follow the steps below to correctly install your memory modules in the memory sockets.

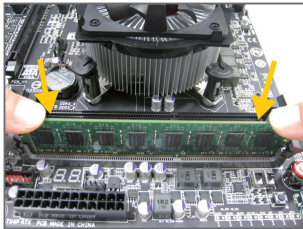

### Step 1:

Note the orientation of the memory module. Spread the retaining clips at both ends of the memory socket. Place the memory module on the socket. As indicated in the picture on the left, place your fingers on the top edge of the memory, push down on the memory and insert it vertically into the memory socket.

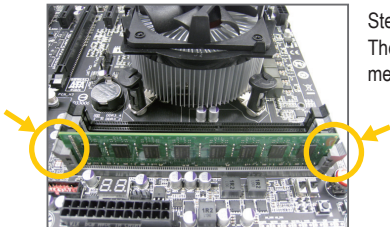

### Step 2:

The clips at both ends of the socket will snap into place when the memory module is securely inserted.

## 1-5 Installing an Expansion Card



Read the following guidelines before you begin to install an expansion card:

- Make sure the motherboard supports the expansion card. Carefully read the manual that came with your expansion card.
- Always turn off the computer and unplug the power cord from the power outlet before installing an expansion card to prevent hardware damage.

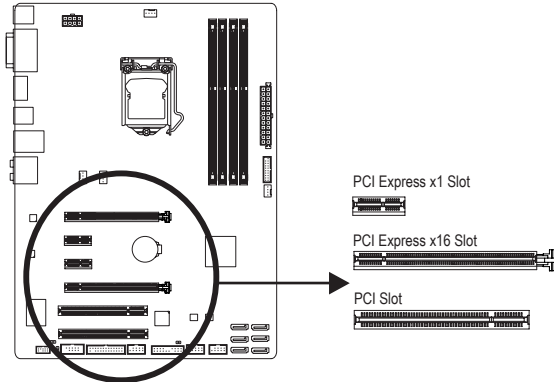

Follow the steps below to correctly install your expansion card in the expansion slot.

1. Locate an expansion slot that supports your card. Remove the metal slot cover from the chassis back panel.
2. Align the card with the slot, and press down on the card until it is fully seated in the slot.
3. Make sure the metal contacts on the card are completely inserted into the slot.
4. Secure the card's metal bracket to the chassis back panel with a screw.
5. After installing all expansion cards, replace the chassis cover(s).
6. Turn on your computer. If necessary, go to BIOS Setup to make any required BIOS changes for your expansion card(s).
7. Install the driver provided with the expansion card in your operating system.

Example: Installing and Removing a PCI Express Graphics Card:



- **Installing a Graphics Card:**  
Gently push down on the top edge of the card until it is fully inserted into the PCI Express slot. Make sure the card is securely seated in the slot and does not rock.

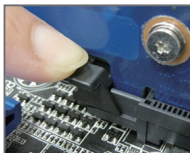

- **Removing the Card:**  
Gently push back on the lever on the slot and then lift the card straight out from the slot.

## 1-6 Back Panel Connectors

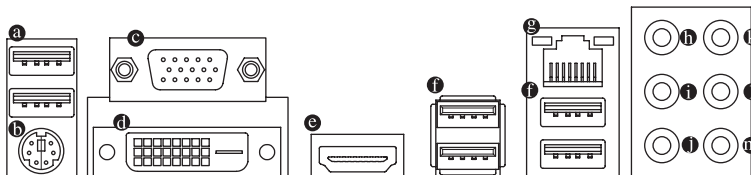

### **a** USB 2.0/1.1 Port

The USB port supports the USB 2.0/1.1 specification. Use this port for USB devices such as a USB keyboard/mouse, USB printer, USB flash drive and etc.

### **b** PS/2 Keyboard/Mouse Port

Use this port to connect a PS/2 mouse or keyboard.

### **c** D-Sub Port

The D-Sub port supports a 15-pin D-Sub connector and supports a maximum resolution of 1920x1200 (the actual resolutions supported depend on the monitor being used). Connect a monitor that supports D-Sub connection to this port.

### **d** DVI-D Port *(Note)*

The DVI-D port conforms to the DVI-D specification and supports a maximum resolution of 1920x1200 (the actual resolutions supported depend on the monitor being used). Connect a monitor that supports DVI-D connection to this port.

### **e** HDMI Port

**HDMI**™ The HDMI port is HDCP compliant and supports Dolby True HD and DTS HD Master Audio formats. It also supports up to 192KHz/24bit 8-channel LPCM audio output. You can use this port to connect your HDMI-supported monitor. The maximum supported resolution is 4096x2160, but the actual resolutions supported are dependent on the monitor being used.



After installing the HDMI device, make sure to set the default sound playback device to HDMI. (The item name may differ depending on your operating system. The screenshot below is from Windows 8.)

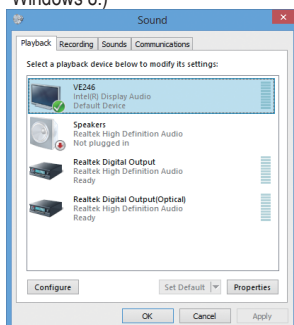

In Windows 8, select All apps>Control Panel>Hardware and Sound>Sound>Playback, set Intel(R) Display Audio to the default playback device.

(Note) The DVI-D port does not support D-Sub connection by adapter.



- When removing the cable connected to a back panel connector, first remove the cable from your device and then remove it from the motherboard.
- When removing the cable, pull it straight out from the connector. Do not rock it side to side to prevent an electrical short inside the cable connector.

## Triple-Display Configurations for the Onboard Graphics:

Triple-display configurations are supported after you install motherboard drivers in OS. Only dual-display configurations are supported during the BIOS Setup or POST process.

### ① USB 3.0/2.0 Port

The USB 3.0 port supports the USB 3.0 specification and is compatible to the USB 2.0/1.1 specification. Use this port for USB devices such as a USB keyboard/mouse, USB printer, USB flash drive and etc.

### ③ RJ-45 LAN Port

The Gigabit Ethernet LAN port provides Internet connection at up to 1 Gbps data rate. The following describes the states of the LAN port LEDs.

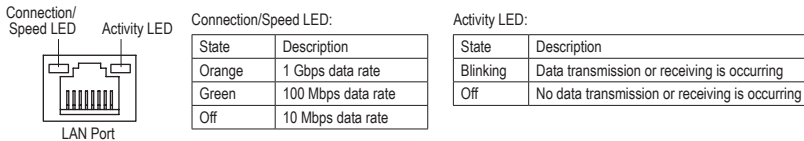

### ① Center/Subwoofer Speaker Out Jack (Orange)

Use this audio jack to connect center/subwoofer speakers in a 5.1/7.1-channel audio configuration.

### ① Rear Speaker Out Jack (Black)

This jack can be used to connect front speakers in a 4/5.1/7.1-channel audio configuration.

### ① Side Speaker Out Jack (Gray)

Use this audio jack to connect side speakers in a 7.1-channel audio configuration.

### ③ Line In Jack (Blue)

The default line in jack. Use this audio jack for line in devices such as an optical drive, walkman, etc.

### ① Line Out Jack (Green)

The default line out jack. Use this audio jack for a headphone or 2-channel speaker. This jack can be used to connect front speakers in a 4/5.1/7.1-channel audio configuration.

### ① Mic In Jack (Pink)

The default Mic in jack. Microphones must be connected to this jack.



The audio jacks can be reconfigured to perform different functions via the audio software(supported functions for each jack may vary based on hardware specification). Only microphones still MUST be connected to the default Mic in jack. Refer to the instructions on setting up a 2/4/5.1/7.1-channel audio configuration in Chapter 6, "Configuring 2/4/5.1/7.1-Channel Audio."



## 1-7 Internal Connectors

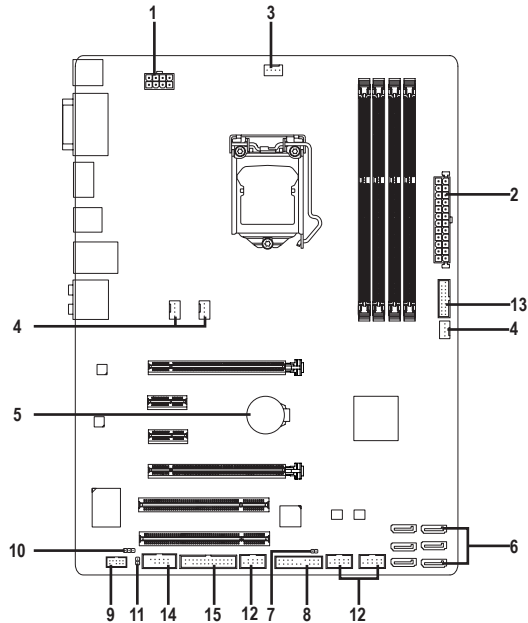

1) ATX_12V_2X4	9) F_AUDIO
2) ATX	10) SPDIF_IN
3) CPU_FAN	11) SPDIF_O
4) SYS_FAN1/2/3	12) F_USB1/F_USB2/F_USB3
5) BAT	13) F_USB30
6) SATA3 0/1/2/3/4/5	14) COMA
7) CLR_CMOS	15) LPT
8) F_PANEL	



Read the following guidelines before connecting external devices:

- First make sure your devices are compliant with the connectors you wish to connect.
- Before installing the devices, be sure to turn off the devices and your computer. Unplug the power cord from the power outlet to prevent damage to the devices.
- After installing the device and before turning on the computer, make sure the device cable has been securely attached to the connector on the motherboard.

## 1/2) ATX\_12V\_2X4/ATX (2x4 12V Power Connector and 2x12 Main Power Connector)

With the use of the power connector, the power supply can supply enough stable power to all the components on the motherboard. Before connecting the power connector, first make sure the power supply is turned off and all devices are properly installed. The power connector possesses a foolproof design. Connect the power supply cable to the power connector in the correct orientation.

The 12V power connector mainly supplies power to the CPU. If the 12V power connector is not connected, the computer will not start.



To meet expansion requirements, it is recommended that a power supply that can withstand high power consumption be used (500W or greater). If a power supply is used that does not provide the required power, the result can lead to an unstable or unbootable system.

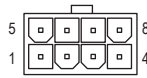
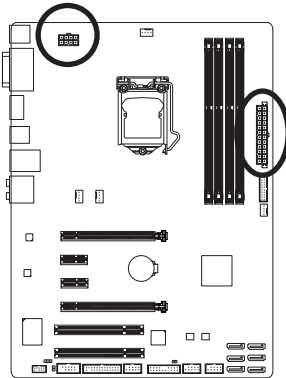

ATX\_12V\_2X4

ATX\_12V\_2X4:

Pin No.	Definition
1	GND (Only for 2x4-pin 12V)
2	GND (Only for 2x4-pin 12V)
3	GND
4	GND
5	+12V (Only for 2x4-pin 12V)
6	+12V (Only for 2x4-pin 12V)
7	+12V
8	+12V

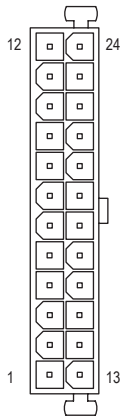

ATX

ATX:

Pin No.	Definition	Pin No.	Definition
1	3.3V	13	3.3V
2	3.3V	14	-12V
3	GND	15	GND
4	+5V	16	PS_ON (soft On/Off)
5	GND	17	GND
6	+5V	18	GND
7	GND	19	GND
8	Power Good	20	-5V
9	5VSB (stand by +5V)	21	+5V
10	+12V	22	+5V
11	+12V (Only for 2x12-pin ATX)	23	+5V (Only for 2x12-pin ATX)
12	3.3V (Only for 2x12-pin ATX)	24	GND (Only for 2x12-pin ATX)

### 3/4) CPU\_FAN/SYS\_FAN1/SYS\_FAN2/SYS\_FAN3 (Fan Headers)

All fan headers on this motherboard are 4-pin. Most fan headers possess a foolproof insertion design. When connecting a fan cable, be sure to connect it in the correct orientation (the black connector wire is the ground wire). The speed control function requires the use of a fan with fan speed control design. For optimum heat dissipation, it is recommended that a system fan be installed inside the chassis.

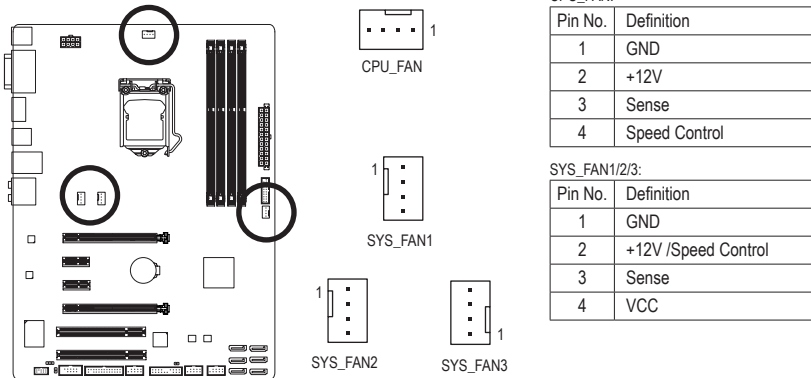

- Be sure to connect fan cables to the fan headers to prevent your CPU and system from overheating. Overheating may result in damage to the CPU or the system may hang.
- These fan headers are not configuration jumper blocks. Do not place a jumper cap on the headers.

### 5) BAT (Battery)

The battery provides power to keep the values (such as BIOS configurations, date, and time information) in the CMOS when the computer is turned off. Replace the battery when the battery voltage drops to a low level, or the CMOS values may not be accurate or may be lost.

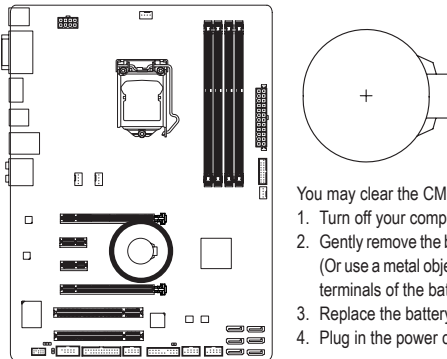

You may clear the CMOS values by removing the battery:

1. Turn off your computer and unplug the power cord.
2. Gently remove the battery from the battery holder and wait for one minute.  
(Or use a metal object like a screwdriver to touch the positive and negative terminals of the battery holder, making them short for 5 seconds.)
3. Replace the battery.
4. Plug in the power cord and restart your computer.



- Always turn off your computer and unplug the power cord before replacing the battery.
- Replace the battery with an equivalent one. Danger of explosion if the battery is replaced with an incorrect model.
- Contact the place of purchase or local dealer if you are not able to replace the battery by yourself or uncertain about the battery model.
- When installing the battery, note the orientation of the positive side (+) and the negative side (-) of the battery (the positive side should face up).
- Used batteries must be handled in accordance with local environmental regulations.

## 6) SATA3 0/1/2/3/4/5 (SATA 6Gb/s Connectors)

The SATA connectors conform to SATA 6Gb/s standard and are compatible with SATA 3Gb/s and SATA 1.5Gb/s standard. Each SATA connector supports a single SATA device. The Intel® Z87/H87 Chipset supports RAID 0, RAID 1, RAID 5, and RAID 10. Refer to Chapter 3, "Configuring SATA Hard Drive(s)," for instructions on configuring a RAID array.

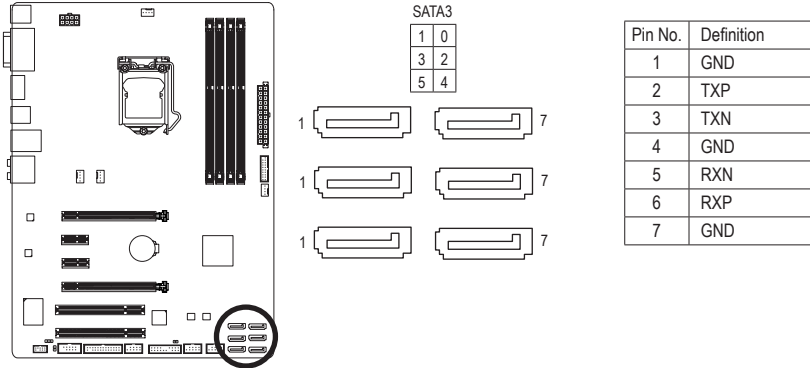

- A RAID 0 or RAID 1 configuration requires at least two hard drives. If more than two hard drives are to be used, the total number of hard drives must be an even number.
- A RAID 5 configuration requires at least three hard drives. (The total number of hard drives does not have to be an even number.)
- A RAID 10 configuration requires four hard drives.

## 7) CLR\_CMOS (Clear CMOS Jumper)

Use this jumper to clear the BIOS configurations and reset the CMOS values to factory defaults. To clear the CMOS values, use a metal object like a screwdriver to touch the two pins for a few seconds.

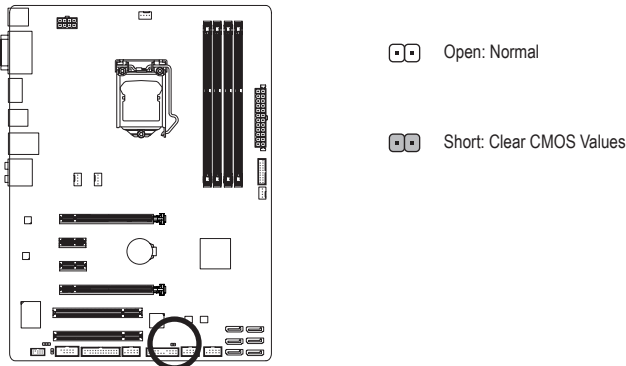

- Always turn off your computer and unplug the power cord from the power outlet before clearing the CMOS values.
- After system restart, go to BIOS Setup to load factory defaults (select Load Optimized Defaults) or manually configure the BIOS settings (refer to Chapter 2, "BIOS Setup," for BIOS configurations).

## 8) F\_PANEL (Front Panel Header)

Connect the power switch, reset switch, speaker, chassis intrusion switch/sensor and system status indicator on the chassis to this header according to the pin assignments below. Note the positive and negative pins before connecting the cables.

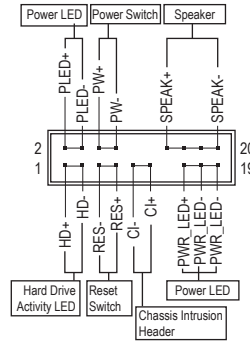
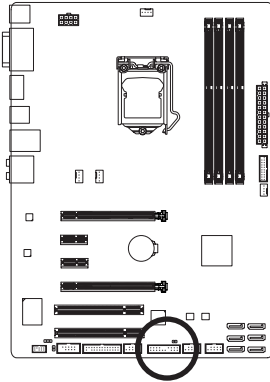

- **PLED/PWR\_LED** (Power LED, Yellow/Purple):

System Status	LED
S0	On
S3/S4/S5	Off

Connects to the power status indicator on the chassis front panel. The LED is on when the system is operating. The LED is off when the system is in S3/S4 sleep state or powered off (S5).

- **PW** (Power Switch, Red):  
Connects to the power switch on the chassis front panel. You may configure the way to turn off your system using the power switch (refer to Chapter 2, "BIOS Setup," "Power Management," for more information).
- **SPEAK** (Speaker, Orange):  
Connects to the speaker on the chassis front panel. The system reports system startup status by issuing a beep code. One single short beep will be heard if no problem is detected at system startup. If a problem is detected, the BIOS may issue beeps in different patterns to indicate the problem.
- **HD** (Hard Drive Activity LED, Blue):  
Connects to the hard drive activity LED on the chassis front panel. The LED is on when the hard drive is reading or writing data.
- **RES** (Reset Switch, Green):  
Connects to the reset switch on the chassis front panel. Press the reset switch to restart the computer if the computer freezes and fails to perform a normal restart.
- **CI** (Chassis Intrusion Header, Gray):  
Connects to the chassis intrusion switch/sensor on the chassis that can detect if the chassis cover has been removed. This function requires a chassis with a chassis intrusion switch/sensor.



The front panel design may differ by chassis. A front panel module mainly consists of power switch, reset switch, power LED, hard drive activity LED, speaker and etc. When connecting your chassis front panel module to this header, make sure the wire assignments and the pin assignments are matched correctly.

## 9) F\_AUDIO (Front Panel Audio Header)

The front panel audio header supports Intel High Definition audio (HD) and AC'97 audio. You may connect your chassis front panel audio module to this header. Make sure the wire assignments of the module connector match the pin assignments of the motherboard header. Incorrect connection between the module connector and the motherboard header will make the device unable to work or even damage it.

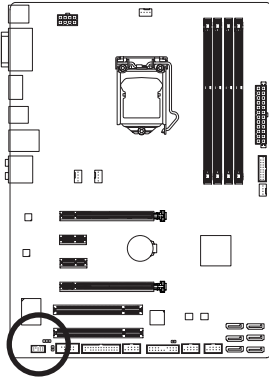

For HD Front Panel Audio:

Pin No.	Definition
1	MIC2_L
2	GND
3	MIC2_R
4	-ACZ_DET
5	LINE2_R
6	GND
7	FAUDIO_JD
8	No Pin
9	LINE2_L
10	GND

For AC'97 Front Panel Audio:

Pin No.	Definition
1	MIC
2	GND
3	MIC Power
4	NC
5	Line Out (R)
6	NC
7	NC
8	No Pin
9	Line Out (L)
10	NC



- The front panel audio header supports HD audio by default. If your chassis provides an AC'97 front panel audio module, refer to the instructions on how to activate AC'97 functionality via the audio software in Chapter 6, "Configuring 2/4/5.1/7.1-Channel Audio."
- Audio signals will be present on both of the front and back panel audio connections simultaneously. If you want to mute the back panel audio (only supported when using an HD front panel audio module), refer to Chapter 6, "Configuring 2/4/5.1/7.1-Channel Audio."
- Some chassis provide a front panel audio module that has separated connectors on each wire instead of a single plug. For information about connecting the front panel audio module that has different wire assignments, please contact the chassis manufacturer.

## 10) SPDIF\_IN (S/PDIF In Header)

This header supports digital S/PDIF In and can connect to an audio device that supports digital audio out via an optional S/PDIF In cable. For purchasing the optional S/PDIF In cable, please contact the local dealer.

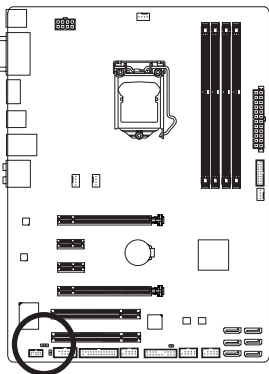

Pin No.	Definition
1	Power
2	SPDIF I
3	GND

## 11) SPDIF\_O (S/PDIF Out Header)

This header supports digital S/PDIF Out and connects a S/PDIF digital audio cable (provided by expansion cards) for digital audio output from your motherboard to certain expansion cards like graphics cards and sound cards. For example, some graphics cards may require you to use a S/PDIF digital audio cable for digital audio output from your motherboard to your graphics card if you wish to connect an HDMI display to the graphics card and have digital audio output from the HDMI display at the same time.

For information about connecting the S/PDIF digital audio cable, carefully read the manual for your expansion card.

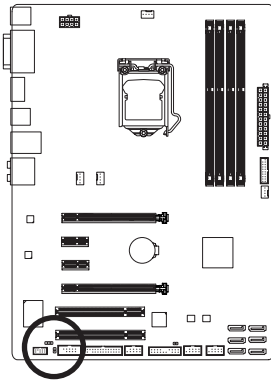

1

Pin No.	Definition
1	SPDIFO
2	GND

## 12) F\_USB1/F\_USB2/F\_USB3 (USB 2.0/1.1 Headers)

The headers conform to USB 2.0/1.1 specification. Each USB header can provide two USB ports via an optional USB bracket. For purchasing the optional USB bracket, please contact the local dealer.

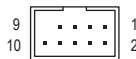
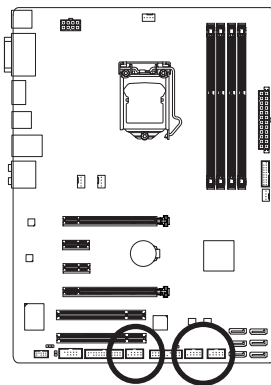

Pin No.	Definition
1	Power (5V)
2	Power (5V)
3	USB DX-
4	USB DY-
5	USB DX+
6	USB DY+
7	GND
8	GND
9	No Pin
10	NC



- Do not plug the IEEE 1394 bracket (2x5-pin) cable into the USB 2.0/1.1 header.
- Prior to installing the USB bracket, be sure to turn off your computer and unplug the power cord from the power outlet to prevent damage to the USB bracket.

### 13) F\_USB30 (USB 3.0/2.0 Header)

The header conforms to USB 3.0/2.0 specification and can provide two USB ports. For purchasing the optional 3.5" front panel that provides two USB 3.0/2.0 ports, please contact the local dealer.

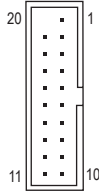
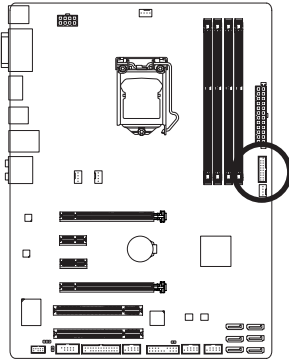

Pin No.	Definition	Pin No.	Definition
1	VBUS	11	D2+
2	SSRX1-	12	D2-
3	SSRX1+	13	GND
4	GND	14	SSTX2+
5	SSTX1-	15	SSTX2-
6	SSTX1+	16	GND
7	GND	17	SSRX2+
8	D1-	18	SSRX2-
9	D1+	19	VBUS
10	NC	20	No Pin



Prior to installing the USB bracket, be sure to turn off your computer and unplug the power cord from the power outlet to prevent damage to the USB bracket.

### 14) COMA (Serial Port Header)

The COM header can provide one serial port via an optional COM port cable. For purchasing the optional COM port cable, please contact the local dealer.

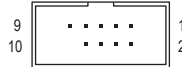
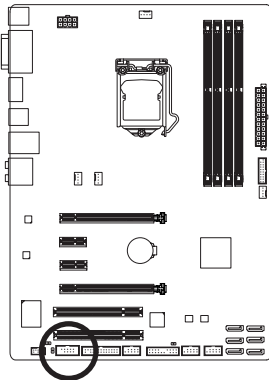

Pin No.	Definition
1	NDCD-
2	NSIN
3	NSOUT
4	NDTR-
5	GND
6	NDSR-
7	NRTS-
8	NCTS-
9	NRI-
10	No Pin



## 15) LPT (Parallel Port Header)

The LPT header can provide one parallel port via an optional LPT port cable. For purchasing the optional LPT port cable, please contact the local dealer.

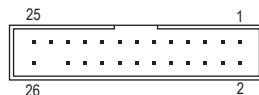
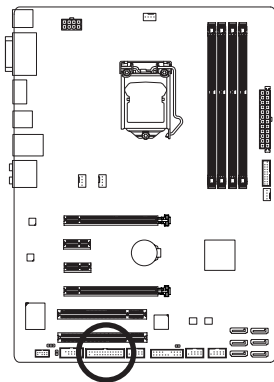

Pin No.	Definition	Pin No.	Definition
1	STB-	14	GND
2	AFD-	15	PD6
3	PD0	16	GND
4	ERR-	17	PD7
5	PD1	18	GND
6	INIT-	19	ACK-
7	PD2	20	GND
8	SLIN-	21	BUSY
9	PD3	22	GND
10	GND	23	PE
11	PD4	24	No Pin
12	GND	25	SLCT
13	PD5	26	GND



## Chapter 2 BIOS Setup

BIOS (Basic Input and Output System) records hardware parameters of the system in the CMOS on the motherboard. Its major functions include conducting the Power-On Self-Test (POST) during system startup, saving system parameters and loading operating system, etc. BIOS includes a BIOS Setup program that allows the user to modify basic system configuration settings or to activate certain system features.

When the power is turned off, the battery on the motherboard supplies the necessary power to the CMOS to keep the configuration values in the CMOS.

To access the BIOS Setup program, press the <Delete> key during the POST when the power is turned on.

To upgrade the BIOS, use either the GIGABYTE Q-Flash or @BIOS utility.

- Q-Flash allows the user to quickly and easily upgrade or back up BIOS without entering the operating system.
- @BIOS is a Windows-based utility that searches and downloads the latest version of BIOS from the Internet and updates the BIOS.

For instructions on using the Q-Flash and @BIOS utilities, refer to Chapter 5, "BIOS Update Utilities."



- Because BIOS flashing is potentially risky, if you do not encounter problems using the current version of BIOS, it is recommended that you not flash the BIOS. To flash the BIOS, do it with caution. Inadequate BIOS flashing may result in system malfunction.
- It is recommended that you not alter the default settings (unless you need to) to prevent system instability or other unexpected results. Inadequately altering the settings may result in system's failure to boot. If this occurs, try to clear the CMOS values and reset the board to default values. (Refer to the "Load Optimized Defaults" section in this chapter or introductions of the battery or the clear CMOS jumper in Chapter 1 for how to clear the CMOS values.)

## 2-1 Startup Screen

The following startup Logo screen will appear when the computer boots.



### Function Keys:

#### <DEL>: BIOS SETUP\Q-FLASH

Press the <Delete> key to enter BIOS Setup or to access the Q-Flash utility in BIOS Setup.

#### <F9>: SYSTEM INFORMATION

Press the <F9> key to display your system information.

#### <F12>: BOOT MENU

Boot Menu allows you to set the first boot device without entering BIOS Setup. In Boot Menu, use the up arrow key <↑> or the down arrow key <↓> to select the first boot device, then press <Enter> to accept. The system will boot from the device immediately.

Note: The setting in Boot Menu is effective for one time only. After system restart, the device boot order will still be based on BIOS Setup settings.

#### <END>: Q-FLASH

Press the <End> key to access the Q-Flash utility directly without having to enter BIOS Setup first.

## 2-2 The Main Menu

### The Main Menu

On the main menu of the BIOS Setup program, press arrow keys to move among the items and press <Enter> to accept or enter a sub-menu. Or you can use your mouse to select the item you want.

(Sample BIOS Version: Z87-HD3 D22c)



### BIOS Setup Program Function Keys

<←><→>	Move the selection bar to select a setup menu
<↑><↓>	Move the selection bar to select a configuration item on a menu
<Enter>	Execute command or enter a menu
<+>/<Page Up>	Increase the numeric value or make changes
<->/<Page Down>	Decrease the numeric value or make changes
<F5>	Restore the previous BIOS settings for the current submenus
<F7>	Load the Optimized BIOS default settings for the current submenus
<F8>	Access the Q-Flash utility
<F9>	Display system information
<F10>	Save all the changes and exit the BIOS Setup program
<F12>	Capture the current screen as an image and save it to your USB drive
<Esc>	Main Menu: Exit the BIOS Setup program Submenus: Exit current submenu

## BIOS Setup Menus

### ■ M.I.T.

Use this menu to configure the clock, frequency, and voltages of your CPU and memory, etc. Or check the system/CPU temperatures, voltages, and fan speeds.

### ■ System

Use this menu to configure the default language used by the BIOS and system time and date. This menu also displays information on the devices connected to the SATA ports.

### ■ BIOS Features

Use this menu to configure the device boot order, advanced features available on the CPU, and the primary display adapter.

### ■ Peripherals

Use this menu to configure all peripheral devices, such as SATA, USB, integrated audio, and integrated LAN, etc.

### ■ Power Management

Use this menu to configure all the power-saving functions.

### ■ Save & Exit

Save all the changes made in the BIOS Setup program to the CMOS and exit BIOS Setup. You can save the current BIOS settings to a profile or load optimized defaults for optimal-performance system operations.



- When the system is not stable as usual, select the **Load Optimized Defaults** item to set your system to its defaults.
- The BIOS Setup menus described in this chapter are for reference only and may differ by BIOS version.

## 2-3 M.I.T.



Whether the system will work stably with the overclock/overvoltage settings you made is dependent on your overall system configurations. Incorrectly doing overclock/overvoltage may result in damage to CPU, chipset, or memory and reduce the useful life of these components. This page is for advanced users only and we recommend you not to alter the default settings to prevent system instability or other unexpected results. (Inadequately altering the settings may result in system's failure to boot. If this occurs, clear the CMOS values and reset the board to default values.)



This section provides information on the BIOS version, CPU base clock, CPU frequency, memory frequency, total memory size, CPU temperature and Vcore.

## ▶ M.I.T. Current Status

This screen provides information on CPU/memory frequencies/parameters.

## ▶ Advanced Frequency Settings



### ☞ CPU/PCIe Base Clock

Allows you to manually set the CPU base clock and PCIe bus frequency in 0.01 MHz increments. (Default: Auto)

**Important: It is highly recommended that the CPU frequency be set in accordance with the CPU specifications.**

### ☞ Host Clock Frequency

Allows you to manually set the host clock frequency (which controls CPU, PCIe, and memory frequencies) in 0.01 MHz increments.

This item is configurable only when **CPU/PCIe Base Clock** is set to **Manual**.

### ☞ Processor Base Clock (Gear Ratio)

Allows you to configure the **Processor Base Clock** by multiplying the **Host Clock Frequency** by several preset host clock multipliers. This item is configurable only when **CPU/PCIe Base Clock** is enabled.

### ☞ Host/PCIe Clock Value

This value is determined by multiplying the **Host Clock Frequency** value by the **Processor Base Clock (Gear Ratio)** value.

### ☞ Processor Graphics Clock

Allows you to set the onboard graphics clock. The adjustable range is from 400 MHz to 4000 MHz. (Default: Auto)

### ☞ CPU Clock Ratio

Allows you to alter the clock ratio for the installed CPU. The adjustable range is dependent on the CPU being installed.

### ☞ CPU Frequency

Displays the current operating CPU frequency.



## ▶ Advanced CPU Core Features



### ☞ CPU Clock Ratio, CPU Frequency

The settings above are synchronous to those under the same items on the **Advanced Frequency Settings** menu.

### ☞ CPU PLL Selection

Allows you to set the CPU PLL. **Auto** lets the BIOS automatically configure this setting. (Default: Auto)

### ☞ Filter PLL Level

Allows you to set the Filter PLL. **Auto** lets the BIOS automatically configure this setting. (Default: Auto)

### ☞ Uncore Ratio

Allows you to set the CPU Uncore ratio. The adjustable range is dependent on the CPU being used.

### ☞ Uncore Frequency

Displays the current CPU Uncore frequency.

### ☞ Intel(R) Turbo Boost Technology <sup>(Note)</sup>

Allows you to determine whether to enable the Intel CPU Turbo Boost technology. **Auto** lets the BIOS automatically configure this setting. (Default: Auto)

### ☞ Turbo Ratio (1-Core Active~4-Core Active) <sup>(Note)</sup>

Allows you to set the CPU Turbo ratios for different number of active cores. Auto sets the CPU Turbo ratios according to the CPU specifications. (Default: Auto)

### ☞ Turbo Power Limit (Watts)

Allows you to set a power limit for CPU Turbo mode. When the CPU power consumption exceeds the specified power limit, the CPU will automatically reduce the core frequency in order to reduce the power. **Auto** sets the power limit according to the CPU specifications. (Default: Auto)

(Note) This item is present only when you install a CPU that supports this feature. For more information about Intel® CPUs' unique features, please visit Intel's website.

- ☞ **Core Current Limit (Amps)**  
 Allows you to set a current limit for CPU Turbo mode. When the CPU current exceeds the specified current limit, the CPU will automatically reduce the core frequency in order to reduce the current. **Auto** sets the power limit according to the CPU specifications. (Default: Auto)
- ☞ **CPU Core Enabled** <sup>(Note 1)</sup>  
 Allows you to determine whether to enable all CPU cores. **Auto** lets the BIOS automatically configure this setting. (Default: Auto)
- ☞ **Hyper-Threading Technology** <sup>(Note 1)</sup>  
 Allows you to determine whether to enable multi-threading technology when using an Intel® CPU that supports this function. This feature only works for operating systems that support multi-processor mode. **Auto** lets the BIOS automatically configure this setting. (Default: Auto)
- ☞ **CPU Enhanced Halt (C1E)** <sup>(Note 1)</sup>  
 Enables or disables Intel® CPU Enhanced Halt (C1E) function, a CPU power-saving function in system halt state. When enabled, the CPU core frequency and voltage will be reduced during system halt state to decrease power consumption. **Auto** lets the BIOS automatically configure this setting. (Default: Auto)
- ☞ **C3/C6 State Support** <sup>(Note 1)</sup>  
 Allows you to determine whether to let the CPU enter C3/C6 mode in system halt state. When enabled, the CPU core frequency and voltage will be reduced during system halt state to decrease power consumption. The C3/C6 state is a more enhanced power-saving state than C1. **Auto** lets the BIOS automatically configure this setting. (Default: Auto)
- ☞ **CPU Thermal Monitor** <sup>(Note 1)</sup>  
 Enables or disables Intel® Thermal Monitor function, a CPU overheating protection function. When enabled, the CPU core frequency and voltage will be reduced when the CPU is overheated. **Auto** lets the BIOS automatically configure this setting. (Default: Auto)
- ☞ **CPU EIST Function** <sup>(Note 1)</sup>  
 Enables or disables Enhanced Intel® Speed Step Technology (EIST). Depending on CPU loading, Intel EIST technology can dynamically and effectively lower the CPU voltage and core frequency to decrease average power consumption and heat production. **Auto** lets the BIOS automatically configure this setting. (Default: Auto)
- ☞ **Extreme Memory Profile (X.M.P.)** <sup>(Note 2)</sup>  
 Allows the BIOS to read the SPD data on XMP memory module(s) to enhance memory performance when enabled.

  - ▶▶ Disabled            Disables this function. (Default)
  - ▶▶ Profile1            Uses Profile 1 settings.
  - ▶▶ Profile2 <sup>(Note 2)</sup>    Uses Profile 2 settings.
- ☞ **System Memory Multiplier**  
 Allows you to set the system memory multiplier. **Auto** sets memory multiplier according to memory SPD data. (Default: Auto)
- ☞ **Memory Frequency (MHz)**  
 The first memory frequency value is the normal operating frequency of the memory being used; the second is the memory frequency that is automatically adjusted according to the **System Memory Multiplier** settings.

(Note 1) This item is present only when you install a CPU that supports this feature. For more information about Intel® CPUs' unique features, please visit Intel's website.

(Note 2) This item is present only when you install a CPU and a memory module that support this feature.

## ▶ Advanced Memory Settings



- **Extreme Memory Profile (X.M.P.)** (Note), **System Memory Multiplier**, **Memory Frequency (MHz)**  
The settings above are synchronous to those under the same items on the **Advanced Frequency Settings** menu.
- **Performance Enhance**  
Allows the system to operate at three different performance levels.
  - ▶▶ Normal Lets the system operate at its basic performance level.
  - ▶▶ Turbo Lets the system operate at its good performance level. (Default)
  - ▶▶ Extreme Lets the system operate at its best performance level.
- **DRAM Timing Selectable**  
**Quick** and **Expert** allows the **Channel Interleaving**, **Rank Interleaving**, and memory timing settings below to be configurable. Options are: Auto (default), Quick, Expert.
- **Profile DDR Voltage**  
When using a non-XMP memory module or **Extreme Memory Profile (X.M.P.)** is set to **Disabled**, this item will display as **1.50V**. When **Extreme Memory Profile (X.M.P.)** is set to **Profile1** or **Profile2**, this item will display the value based on the SPD data on the XMP memory.
- **Channel Interleaving**  
Enables or disables memory channel interleaving. **Enabled** allows the system to simultaneously access different channels of the memory to increase memory performance and stability. **Auto** lets the BIOS automatically configure this setting. (Default: Auto)
- **Rank Interleaving**  
Enables or disables memory rank interleaving. **Enabled** allows the system to simultaneously access different ranks of the memory to increase memory performance and stability. **Auto** lets the BIOS automatically configure this setting. (Default: Auto)

(Note) This item is present only when you install a CPU and a memory module that support this feature.

► Channel A/B Timing Settings



This sub-menu provides memory timing settings for each channel of memory. The respective timing setting screens are configurable only when **DRAM Timing Selectable** is set to **Quick** or **Expert**. Note: Your system may become unstable or fail to boot after you make changes on the memory timings. If this occurs, please reset the board to default values by loading optimized defaults or clearing the CMOS values.

▶ **Advanced Voltage Settings**



▶ **CPU Core Voltage Control**

This section provides CPU voltage control options.

▶ **Chipset Voltage Control**

This section provides Chipset voltage control options.

▶ **DRAM Voltage Control**

This section provides memory voltage control options.

## ► PC Health Status



### ⊞ Reset Case Open Status

- Disabled Keeps or clears the record of previous chassis intrusion status. (Default)
- Enabled Clears the record of previous chassis intrusion status and the **Case Open** field will show "No" at next boot.

### ⊞ Case Open

Displays the detection status of the chassis intrusion detection device attached to the motherboard **CI header**. If the system chassis cover is removed, this field will show "Yes", otherwise it will show "No". To clear the chassis intrusion status record, set **Reset Case Open Status** to **Enabled**, save the settings to the CMOS, and then restart your system.

- ☞ **CPU Vcore/CPU VRIN/DRAM Voltage/+3.3V/+5V/+12V/CPU VAXG**  
Displays the current system voltages.
- ☞ **CPU/System Temperature**  
Displays current CPU/System temperature.
- ☞ **CPU/System Fan Speed**  
Displays current CPU/system fan speeds.
- ☞ **CPU/System Warning Temperature**  
Sets the warning threshold for CPU/system temperature. When CPU temperature exceeds the threshold, BIOS will emit warning sound. Options are: Disabled (default), 60°C/140°F, 70°C/158°F, 80°C/176°F, 90°C/194°F.
- ☞ **CPU/System Fan Fail Warning**  
Allows the system to emit warning sound if the fan is not connected or fail. Check the fan condition or fan connection when this occurs. (Default: Disabled)
- ☞ **CPU Fan Speed Control (CPU\_FAN Connector)**  
Allows you to determine whether to enable the fan speed control function for the fan connected to the CPU\_FAN connector and adjust the fan speed.
  - ▶▶ Normal Allows the fan to run at different speeds according to the CPU temperature. You can adjust the fan speed with EasyTune based on your system requirements. (Default)
  - ▶▶ Silent Allows the fan to run at slow speeds.
  - ▶▶ Manual Allows you to control the fan speed under the **Slope PWM** item.
  - ▶▶ Disabled Allows the fan to run at full speeds.
- ☞ **Slope PWM**  
Allows you to control the fan speed. This item is configurable only when **CPU Fan Speed Control** is set to **Manual**. Options are: 0.75 PWM value /°C ~ 2.50 PWM value /°C.
- ☞ **1st System Fan Speed Control (SYS\_FAN1 Connector)**  
Allows you to determine whether to enable the fan speed control function for the fan connected to the SYS\_FAN1 connector and adjust the fan speed.
  - ▶▶ Normal Allows the fan to run at different speeds according to the system temperature. You can adjust the fan speed with EasyTune based on your system requirements. (Default)
  - ▶▶ Silent Allows the fan to run at slow speeds.
  - ▶▶ Manual Allows you to control the fan speed under the **Slope PWM** item.
  - ▶▶ Disabled Allows the fan to run at full speeds.
- ☞ **Slope PWM**  
Allows you to control the fan speed. This item is configurable only when **1st System Fan Speed Control** is set to **Manual**. Options are: 0.75 PWM value /°C ~ 2.50 PWM value /°C.
- ☞ **2nd/3rd System Fan Speed Control**  
Allows you to determine whether to enable the fan speed control function for the system fan connected to the SYS\_FAN2/3 connector and adjust the fan speed.
  - ▶▶ Normal Allows the fan to run at different speeds according to the system temperature. (Default)
  - ▶▶ Silent Allows the fan to run at slow speeds.
  - ▶▶ Manual Allows you to control the fan speed under the Slope PWM item.
  - ▶▶ Disabled Allows the fan to run at full speeds.

☞ **Slope PWM**

Allows you to control the fan speed. This item is configurable only when **2nd/3rd System Fan Speed Control** is set to **Manual**. Options are: 0.75 PWM value /°C ~ 2.50 PWM value /°C.

▶ **Miscellaneous Settings**



☞ **PEG Gen3 Slot Configuration**

Allows you to set the operation mode of the PCI Express slots to Gen 1, Gen 2, or Gen 3. Actual operation mode is subject to the hardware specification of each slot. For example, the PCI Express x1 slots can support up to Gen 2 mode only. **Auto** lets the BIOS automatically configure this setting. (Default: Auto)

☞ **Legacy BenchMark Enhancement**

Allows you to determine whether to enhance some legacy benchmark performance. (Default: Disabled)



## 2-4 System



This section provides information on your CPU, memory, motherboard model, and BIOS version. You can also select the default language used by the BIOS and manually set the system time.

### System Language

Selects the default language used by the BIOS.

### System Date

Sets the system date. The date format is week (read-only), month, date, and year. Use <Enter> to switch between the Month, Date, and Year fields and use the <Page Up> or <Page Down> key to set the desired value.

### System Time

Sets the system time. The time format is hour, minute, and second. For example, 1 p.m. is 13:0:0. Use <Enter> to switch between the **H**our, **M**inute, and **S**econd fields and use the <Page Up> or <Page Down> key to set the desired value.

### Access Level

Displays the current access level depending on the type of password protection used. (If no password is set, the default will display as **Administrator**.) The Administrator level allows you to make changes to all BIOS settings; the User level only allows you to make changes to certain BIOS settings but not all.

## 2-5 BIOS Features



### Boot Option Priorities

Specifies the overall boot order from the available devices. For example, you can set hard drive as the first priority (**Boot Option #1**) and DVD ROM drive as the second priority (**Boot Option #2**). The list only displays the device with the highest priority for a specific type. For example, only hard drive defined as the first priority on the **Hard Drive BBS Priorities** submenu will be presented here.

Removable storage devices that support GPT format will be prefixed with "UEFI:" string on the boot device list. To boot from an operating system that supports GPT partitioning, select the device prefixed with "UEFI:" string.

Or if you want to install an operating system that supports GPT partitioning such as Windows 7 64-bit, select the optical drive that contains the Windows 7 64-bit installation disk and is prefixed with "UEFI:" string.

- ☞ **Hard Drive/CD/DVD ROM Drive/Floppy Drive/Network Device BBS Priorities**  
 Specifies the boot order for a specific device type, such as hard drives, optical drives, floppy disk drives, and devices that support Boot from LAN function, etc. Press <Enter> on this item to enter the submenu that presents the devices of the same type that are connected. This item is present only if at least one device for this type is installed.
  - ☞ **Bootup NumLock State**  
 Enables or disables Numlock feature on the numeric keypad of the keyboard after the POST. (Default: Enabled)
  - ☞ **Security Option**  
 Specifies whether a password is required every time the system boots, or only when you enter BIOS Setup. After configuring this item, set the password(s) under the **Administrator Password/User Password** item.

    - ▶▶ Setup            A password is only required for entering the BIOS Setup program.
    - ▶▶ System           A password is required for booting the system and for entering the BIOS Setup program. (Default)
  - ☞ **Full Screen LOGO Show**  
 Allows you to determine whether to display the GIGABYTE Logo at system startup. **Disabled** skips the GIGABYTE Logo when the system starts up. (Default: Enabled)
  - ☞ **Fast Boot**  
 Enables or disables Fast Boot to shorten the OS boot process. **Ultra Fast** provides the fastest bootup speed. (Default: Disabled)
  - ☞ **Limit CPUID Maximum** <sup>(Note)</sup>  
 Allows you to determine whether to limit CPUID maximum value. Set this item to **Disabled** for Windows XP operating system; set this item to **Enabled** for legacy operating system such as Windows NT4.0. (Default: Disabled)
  - ☞ **Execute Disable Bit** <sup>(Note)</sup>  
 Enables or disables Intel® Execute Disable Bit function. This function may enhance protection for the computer, reducing exposure to viruses and malicious buffer overflow attacks when working with its supporting software and system. (Default: Enabled)
  - ☞ **Intel Virtualization Technology** <sup>(Note)</sup>  
 Enables or disables Intel® Virtualization Technology. Virtualization enhanced by Intel® Virtualization Technology will allow a platform to run multiple operating systems and applications in independent partitions. With virtualization, one computer system can function as multiple virtual systems. (Default: Enabled)
  - ☞ **Intel TXT(LT) Support** <sup>(Note)</sup>  
 Enables or disables Intel® Trusted Execution Technology (Intel® TXT). Intel® Trusted Execution Technology provides a hardware-based security foundation. (Default: Disabled)
  - ☞ **Dynamic Storage Accelerator** ①  
 Enables or disables Intel® Dynamic Storage Accelerator. When enabled, the hard drive I/O performance will be adjusted according to hard drive load. (Default: Disabled)
  - ☞ **VT-d** <sup>(Note)</sup>  
 Enables or disables Intel® Virtualization Technology for Directed I/O. (Default: Enabled)
- ① Only for GA-Z87-HD3.

(Note) This item is present only when you install a CPU that supports this feature. For more information about Intel® CPUs' unique features, please visit Intel's website.

### ⊟ **OS Type**

Allows you to select the operating system to be installed. (Default: Other OS)

### ⊟ **CSM Support**

Enables or disables UEFI CSM (Compatibility Support Module) to support a legacy PC boot process.

- ▶▶ Always Enables UEFI CSM. (Default)
- ▶▶ Never Disables UEFI CSM and supports UEFI BIOS boot process only.

This item is configurable only when **OS Type** is set to **Windows 8** or **Windows 8 WHQL**.

### ⊟ **Boot Mode Selection**

Allows you to select which type of operating system to boot.

- ▶▶ UEFI and Legacy Allows booting from operating systems that support legacy option ROM or UEFI option ROM. (Default)
- ▶▶ Legacy only Allows booting from operating systems that only support legacy option ROM.
- ▶▶ UEFI only Allows booting from operating systems that only support UEFI option ROM.

This item is configurable only when **CSM Support** is set to **Always**.

### ⊟ **LAN PXE Boot Option ROM**

Allows you to select whether to enable the legacy option ROM for the LAN controller. (Default: Disabled)

This item is configurable only when **CSM Support** is set to **Always**.

### ⊟ **Storage Boot Option Control**

Allows you to select whether to enable the UEFI or legacy option ROM for the storage device controller.

- ▶▶ Disabled Disables option ROM.
- ▶▶ Legacy only Enables legacy option ROM only. (Default)
- ▶▶ UEFI only Enables UEFI option ROM only.
- ▶▶ Legacy First Enables legacy option ROM first.
- ▶▶ UEFI First Enables UEFI option ROM first.

This item is configurable only when **CSM Support** is set to **Always**.

### ⊟ **Other PCI Device ROM Priority**

Allows you to select whether to enable the UEFI or Legacy option ROM for the PCI device controller other than the LAN, storage device, and graphics controllers.

- ▶▶ Legacy OpROM Enables legacy option ROM only.
- ▶▶ UEFI OpROM Enables UEFI option ROM only. (Default)

### ⊟ **Network stack**

Disables or enables booting from the network to install a GPT format OS, such as installing the OS from the Windows Deployment Services server. (Default: Disabled)

### ⊟ **Ipv4 PXE Support**

Enables or disables IPv4 PXE Support. This item is configurable only when **Network stack** is enabled.

### ⊟ **Ipv6 PXE Support**

Enables or disables IPv6 PXE Support. This item is configurable only when **Network stack** is enabled.

☞ **Administrator Password**

Allows you to configure an administrator password. Press <Enter> on this item, type the password, and then press <Enter>. You will be requested to confirm the password. Type the password again and press <Enter>. You must enter the administrator password (or user password) at system startup and when entering BIOS Setup. Differing from the user password, the administrator password allows you to make changes to all BIOS settings.

☞ **User Password**

Allows you to configure a user password. Press <Enter> on this item, type the password, and then press <Enter>. You will be requested to confirm the password. Type the password again and press <Enter>.

You must enter the administrator password (or user password) at system startup and when entering BIOS Setup. However, the user password only allows you to make changes to certain BIOS settings but not all.

To cancel the password, press <Enter> on the password item and when requested for the password, enter the correct one first. When prompted for a new password, press <Enter> without entering any password. Press <Enter> again when prompted to confirm.

## 2-6 Peripherals



### ☞ XHCI Mode (Intel® Z87/H87 Chipset)

Allows you to determine the operating mode for the xHCI controller in OS.

- ▶▶ Smart Auto This mode is available only when the BIOS supports the xHCI controller in the pre-boot environment. This mode is similar to **Auto**, but it adds the capability to route the ports to xHCI or EHCI according to setting used in previous boots (for non-G3 boot) in the pre-boot environment. This allows the use of USB 3.0 devices prior to OS boot. xHCI controller enabling and rerouting should follow the steps in **Auto**, when previous boot routes ports to EHCI. Note: This is the recommended mode when BIOS has xHCI pre-boot support. (Default)
- ▶▶ Auto BIOS routes the sharable ports to EHCI controller. Then it uses ACPI protocols to provide an option to enable the xHCI controller and reroute the sharable ports. Note: This is the recommended mode when BIOS does NOT have xHCI pre-boot support.
- ▶▶ Enabled All shared ports are eventually routed to the xHCI controller during the BIOS boot process. If BIOS does not have pre-boot support for the xHCI controller, it should initially route the sharable ports to the EHCI controller and then prior to OS boot it should route the ports to xHCI controller. Note: OS has to provide support for the xHCI controller in this mode. If the OS does not provide support, all sharable ports won't work.
- ▶▶ Disabled The USB 3.0 ports are routed to the EHCI controller and the xHCI controller is turned off. All USB 3.0 devices function as High Speed devices regardless of xHCI software support/availability.
- ▶▶ Manual Allows you to determine whether to route the USB 3.0 ports to the xHCI or EHCI controller before booting to OS, and also provides you with options to manually route each USB 3.0/2.0 port to xHCI or EHCI.

☞ **Audio Controller**

Enables or disables the onboard audio function. (Default: Auto)

If you wish to install a 3rd party add-in audio card instead of using the onboard audio, set this item to **Disabled**.

☞ **Init Display First**

Specifies the first initiation of the monitor display from the installed PCI graphics card, PCI Express graphics card or the onboard graphics.

- ▶▶ IGFX            Sets the onboard graphics as the first display.
- ▶▶ PCIe 1 Slot    Sets the graphics card on the PCIeX16 slot as the first display. (Default)
- ▶▶ PCIe 2 Slot    Sets the graphics card on the PCIeX4 slot as the first display.
- ▶▶ PCI            Sets the graphics card on the PCI slot as the first display.

☞ **Internal Graphics**

Enables or disables the onboard graphics function. (Default: Auto)

☞ **Internal Graphics Memory Size**

Allows you to set the onboard graphics memory size. Options are: 32M~1024M. (Default: 64M)

☞ **DVMT Total Memory Size**

Allows you to allocate the DVMT memory size of the onboard graphics. Options are: 128M, 256M, MAX. (Default: MAX)

☞ **Intel(R) Rapid Start Technology**

Enables or disables Intel® Rapid Start Technology. (Default: Disabled)

☞ **Legacy USB Support**

Allows USB keyboard/mouse to be used in MS-DOS. (Default: Enabled)

☞ **XHCI Hand-off**

Determines whether to enable XHCI Hand-off feature for an operating system without XHCI Hand-off support. (Default: Enabled)

☞ **EHCI Hand-off**

Determines whether to enable EHCI Hand-off feature for an operating system without EHCI Hand-off support. (Default: Disabled)

☞ **USB Storage Devices**

Displays a list of connected USB mass storage devices. This item appears only when a USB storage device is installed.

☞ **OnBoard LAN Controller#1 (Realtek® GbE LAN Chip)**

Enables or disables the onboard Realtek GbE LAN function. (Default: Enabled)

If you wish to install a 3rd party add-in network card instead of using the onboard LAN, set this item to **Disabled**.

☞ **PCIe Slot Configuration**

Specifies the operating bandwidth for the PCIeX4 slot.

- ▶▶ Auto    Lets the BIOS automatically configure this setting depending on the expansion card being installed. (Default)
- ▶▶ x1      PCIeX4 operates at x1 mode.
- ▶▶ x4      PCIeX4 operates at x4 mode.

## ▶ SATA Configuration



- ☞ **SATA Controller(s) (Intel® Z87/H87 Chipset)**  
Enables or disables the integrated SATA controllers. (Default: Enabled)
- ☞ **SATA Mode Selection (Intel® Z87/H87 Chipset)**  
Enables or disables RAID for the SATA controllers or configures the SATA controllers to AHCI mode.
  - ▶▶ IDE Configures the SATA controller to IDE mode.
  - ▶▶ RAID Enables RAID for the SATA controller.
  - ▶▶ AHCI Configures the SATA controllers to AHCI mode. Advanced Host Controller Interface (AHCI) is an interface specification that allows the storage driver to enable advanced Serial ATA features such as Native Command Queuing and hot plug. (Default)
- ▶ **Serial ATA Port 0/1/2/3/4/5**
  - ☞ **Port 0/1/2/3/4/5**  
Enables or disables each SATA port. (Default: Enabled)
  - ☞ **Hot plug**  
Enables or disable the hot plug capability for each SATA port. (Default: Disabled)
- ▶ **Super IO Configuration**  
This section provides information on the super I/O chip and allows you to configure the serial port and parallel port.
  - ☞ **Serial Port A**  
Enables or disables the onboard serial port. (Default: Enabled)
  - ☞ **Parallel Port**  
Enables or disables the onboard parallel port. (Default: Enabled)



☞ **Device Mode**

This item is configurable only when **Parallel Port** is set to **Enabled**. Selects an operating mode for the onboard parallel (LPT) port. (Default), EPP Mode (Enhanced Parallel Port), ECP Mode (Extended Capabilities Port), EPP Mode & ECP Mode.

▶ **Intel(R) Smart Connect Technology**

☞ **ISCT Configuration**

Enables or disables Intel® Smart Connect Technology. (Default: Disabled)

▶ **Realtek PCIe GBE Family Controller**

This sub-menu provides information on LAN configuration.

## 2-7 Power Management



### ☞ Resume by Alarm

Determines whether to power on the system at a desired time. (Default: Disabled)

If enabled, set the date and time as following:

- ▶▶ Wake up day: Turn on the system at a specific time on each day or on a specific day in a month.
- ▶▶ Wake up hour/minute/second: Set the time at which the system will be powered on automatically.

Note: When using this function, avoid inadequate shutdown from the operating system or removal of the AC power, or the settings may not be effective.

### ☞ ErP

Determines whether to let the system consume least power in S5 (shutdown) state. (Default: Disabled)

Note: When this item is set to **Enabled**, the following functions will become unavailable: PME event wake up, power on by mouse, power on by keyboard, and wake on LAN.

### ☞ Soft-Off by PWR-BTTN

Configures the way to turn off the computer in MS-DOS mode using the power button.

- ▶▶ Instant-Off Press the power button and then the system will be turned off instantly. (Default)
- ▶▶ Delay 4 Sec Press and hold the power button for 4 seconds to turn off the system. If the power button is pressed for less than 4 seconds, the system will enter suspend mode.

### ☞ RC6(Render Standby)

Allows you to determine whether to let the onboard graphics enter standby mode to decrease power consumption. (Default: Enabled)

### ☞ AC BACK

Determines the state of the system after the return of power from an AC power loss.

- ▶▶ Always Off The system stays off upon the return of the AC power. (Default)
- ▶▶ Always On The system is turned on upon the return of the AC power.
- ▶▶ Memory The system returns to its last known awake state upon the return of the AC power.

### ☞ **Power On By Keyboard**

Allows the system to be turned on by a PS/2 keyboard wake-up event.

Note: To use this function, you need an ATX power supply providing at least 1A on the +5VSB lead.

- ▶▶ Disabled      Disables this function. (Default)
- ▶▶ Any Key        Press any key to turn on the system.
- ▶▶ Keyboard 98    Press POWER button on the Windows 98 keyboard to turn on the system.
- ▶▶ Password       Set a password with 1~5 characters to turn on the system.

### ☞ **Power On Password**

Set the password when **Power On by Keyboard** is set to **Password**.

Press <Enter> on this item and set a password with up to 5 characters and then press <Enter> to accept.

To turn on the system, enter the password and press <Enter>.

Note: To cancel the password, press <Enter> on this item. When prompted for the password, press <Enter> again without entering the password to clear the password settings.

### ☞ **Power On By Mouse**

Allows the system to be turned on by a PS/2 mouse wake-up event.

Note: To use this function, you need an ATX power supply providing at least 1A on the +5VSB lead.

- ▶▶ Disabled      Disables this function. (Default)
- ▶▶ Move          Move the mouse to turn on the system.
- ▶▶ Double Click    Double click on left button on the mouse to turn on the system.

## 2-8 Save & Exit



### Save & Exit Setup

Press <Enter> on this item and select **Yes**. This saves the changes to the CMOS and exits the BIOS Setup program. Select **No** or press <Esc> to return to the BIOS Setup Main Menu.

### Exit Without Saving

Press <Enter> on this item and select **Yes**. This exits the BIOS Setup without saving the changes made in BIOS Setup to the CMOS. Select **No** or press <Esc> to return to the BIOS Setup Main Menu.

### Load Optimized Defaults

Press <Enter> on this item and select **Yes** to load the optimal BIOS default settings. The BIOS default settings help the system to operate in optimum state. Always load the Optimized defaults after updating the BIOS or after clearing the CMOS values.

### Boot Override

Allows you to select a device to boot immediately. Press <Enter> on the device you select and select **Yes** to confirm. Your system will restart automatically and boot from that device.

### Save Profiles

This function allows you to save the current BIOS settings to a profile. You can create up to 8 profiles and save as Setup Profile 1~ Setup Profile 8. Press <Enter> to complete. Or you can select **Select File in HDD/USB/FDD** to save the profile to your storage device.

### Load Profiles

If your system becomes unstable and you have loaded the BIOS default settings, you can use this function to load the BIOS settings from a profile created before, without the hassles of reconfiguring the BIOS settings. First select the profile you wish to load and then press <Enter> to complete. You can select **Select File in HDD/USB/FDD** to input the profile previously created from your storage device or load the profile automatically created by the BIOS, such as reverting the BIOS settings to the last settings that worked properly (last known good record).

## Chapter 3 Configuring SATA Hard Drive(s)

### RAID Levels

	RAID 0	RAID 1	RAID 5	RAID 10
Minimum Number of Hard Drives	≥2	2	≥3	≥4
Array Capacity	Number of hard drives * Size of the smallest drive	Size of the smallest drive	(Number of hard drives - 1) * Size of the smallest drive	(Number of hard drives/2) * Size of the smallest drive
Fault Tolerance	No	Yes	Yes	Yes

To configure SATA hard drive(s), follow the steps below:

- A. Install SATA hard drive(s) in your computer.
- B. Configure SATA controller mode in BIOS Setup.
- C. Configure a RAID array in RAID BIOS. <sup>(Note 1)</sup>
- D. Install the SATA RAID/AHCI driver and operating system. <sup>(Note 2)</sup>

### Before you begin

Please prepare:

- At least two SATA hard drives (to ensure optimal performance, it is recommended that you use two hard drives with identical model and capacity). If you do not want to create RAID, you may prepare only one hard drive.
- Windows 8/7 setup disk.
- Motherboard driver disk.
- A USB thumb drive

## 3-1 Configuring SATA Controllers

### A. Installing SATA hard drive(s) in your computer

Attach one end of the SATA signal cable to the rear of the SATA hard drive and the other end to available SATA port on the motherboard. Then connect the power connector from your power supply to the hard drive.

(Note 1) Skip this step if you do not want to create RAID array on the SATA controller.

(Note 2) Required when the SATA controller is set to AHCI or RAID mode.

## B. Configuring SATA controller mode in BIOS Setup

Make sure to configure the SATA controller mode correctly in system BIOS Setup.

Step 1:

Turn on your computer and press <Delete> to enter BIOS Setup during the POST (Power-On Self-Test). Go to **Peripherals\SATA Configuration**, make sure **SATA Controllers** is enabled. To create RAID, set **SATA Mode Selection** to **RAID** (Figure 1). If you do not want to create RAID, set this item to **IDE** or **AHCI**.

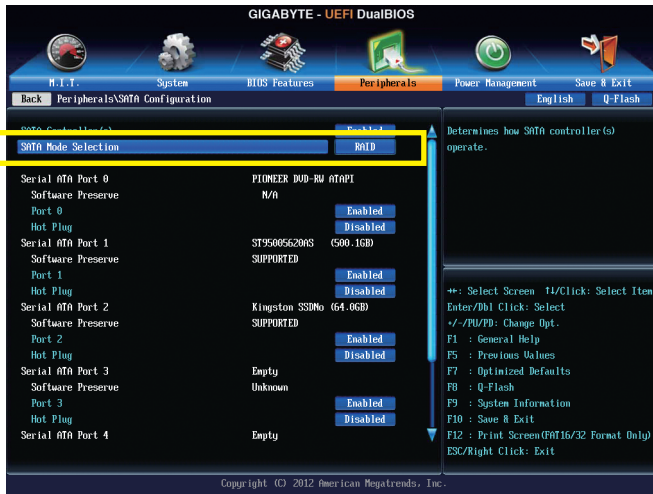

Figure 1

Step 2:

If you want to configure UEFI RAID, follow the steps in "C-1." To enter the legacy RAID ROM, save the settings and exit BIOS Setup. Refer to "C-2" for more information.



The BIOS Setup menus described in this section may differ from the exact settings for your motherboard. The actual BIOS Setup menu options you will see shall depend on the motherboard you have and the BIOS version.

## C-1. UEFI RAID Configuration

This mode supports Windows 8 64-bit installation only.

Step 1:

In BIOS Setup, go to **BIOS Features** and set **OS Type** to **Windows 8** and **CSM Support** to **Never**. (Figure 2)  
Save the changes and exit BIOS Setup.



Figure 2

Step 2:

After the system reboot, enter BIOS Setup again. Then enter the **Peripherals\Intel(R) Rapid Storage Technology** sub-menu (Figure 3).



Figure 3

Step 3:

On the **Intel(R) Rapid Storage Technology** menu, press <Enter> on **Create RAID Volume** to enter the **Create RAID Volume** screen. Enter a volume name with 1~16 letters (letters cannot be special characters) under the **Name** item and press <Enter>. Then, select a RAID level (Figure 4). RAID levels supported include RAID 0, RAID 1, RAID 10, and RAID 5 (the selections available depend on the number of the hard drives being installed). Next, use the down arrow key to move to **Select Disks**.



Figure 4

Step 4:

Under **Select Disks** item, select the hard drives to be included in the RAID array. Press the <Space> key on the hard drives to be selected (selected hard drives are marked with "X"). Then set the stripe block size (Figure 5). The stripe block size can be set from 4 KB to 128 KB. Once you have selected the stripe block size, set the volume capacity.



Figure 5



Step 5:

After setting the capacity, move to **Create Volume** and press <Enter> to begin. (Figure 6)



Figure 6

After completing, you'll be brought back to the **Intel(R) Rapid Storage Technology** screen. Under **RAID Volumes** you can see the new RAID volume. To see more detailed information, press <Enter> on the volume to check for information on RAID level, stripe block size, array name, and array capacity, etc. (Figure 7)



Figure 7

## Delete RAID Volume

To delete a RAID array, press <Enter> on the volume to be deleted on the **Intel(R) Rapid Storage Technology** screen. After entering the **RAID VOLUME INFO** screen, press <Enter> on **Delete** to enter the **Delete** screen. Press <Enter> on **Yes** (Figure 8).

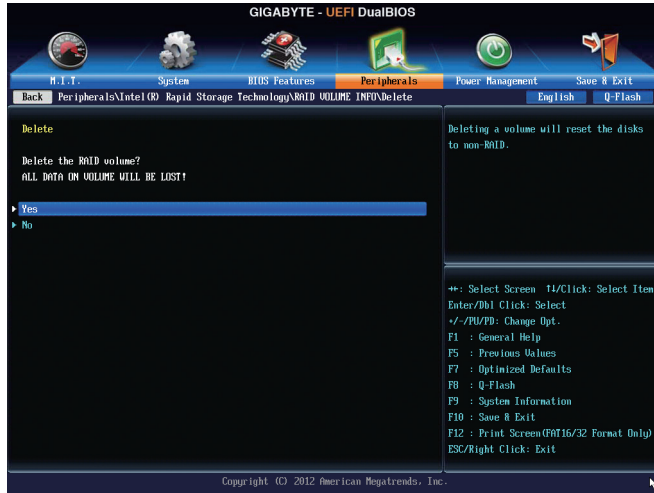

Figure 8

## C-2. Configuring Legacy RAID ROM

Enter the Intel® legacy RAID BIOS setup utility to configure a RAID array. Skip this step and proceed with the installation of Windows operating system for a non-RAID configuration.

### Step 1:

After the POST memory test begins and before the operating system boot begins, look for a message which says "Press <Ctrl-I> to enter Configuration Utility" (Figure 9). Press <Ctrl> + <I> to enter the RAID Configuration Utility.

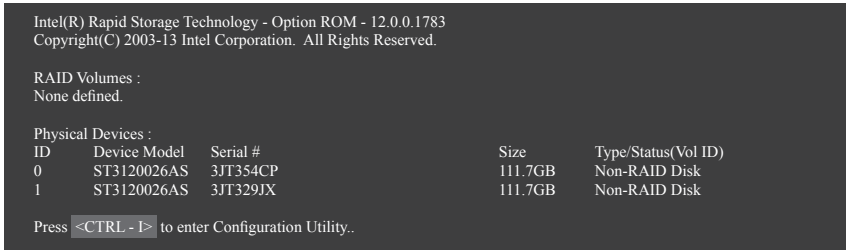

Figure 9

### Step 2:

After you press <Ctrl> + <I>, the **MAIN MENU** screen will appear (Figure 10).

### Create RAID Volume

If you want to create a RAID array, select **Create RAID Volume** in **MAIN MENU** and press <Enter>.

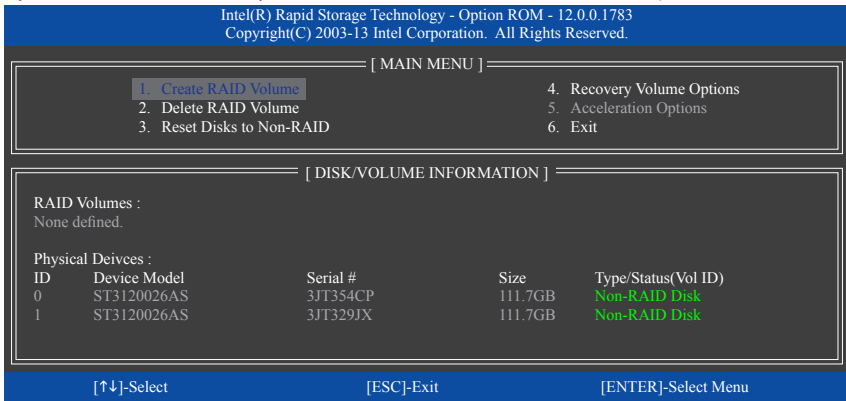

Figure 10

Step 3:

After entering the **CREATE VOLUME MENU** screen, enter a volume name with 1~16 letters (letters cannot be special characters) under the **Name** item and press <Enter>. Then, select a RAID level (Figure 11). RAID levels supported include RAID 0, RAID 1, RAID 10, and RAID 5 (the selections available depend on the number of the hard drives being installed). Press <Enter> to proceed.

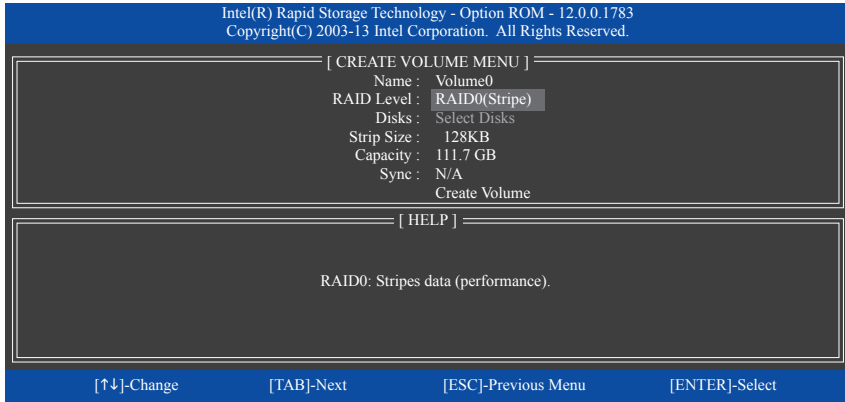

Figure 11

Step 4:

Under **Disks** item, select the hard drives to be included in the RAID array. If only two hard drives are installed, they will be automatically assigned to the array. Set the stripe block size (Figure 12) if necessary. The stripe block size can be set from 4 KB to 128 KB. Once you have selected the stripe block size, press <Enter>.

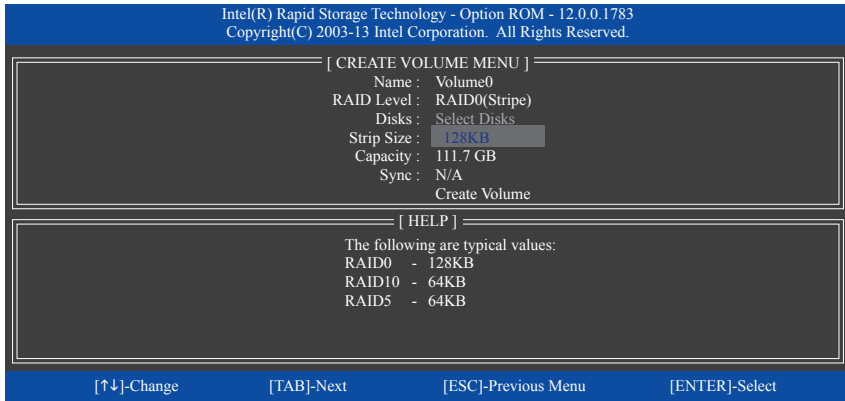

Figure 12

Step 5:

Enter the array capacity and press <Enter>. Finally press <Enter> on the **Create Volume** item to begin creating the RAID array. When prompted to confirm whether to create this volume, press <Y> to confirm or <N> to cancel (Figure 13).

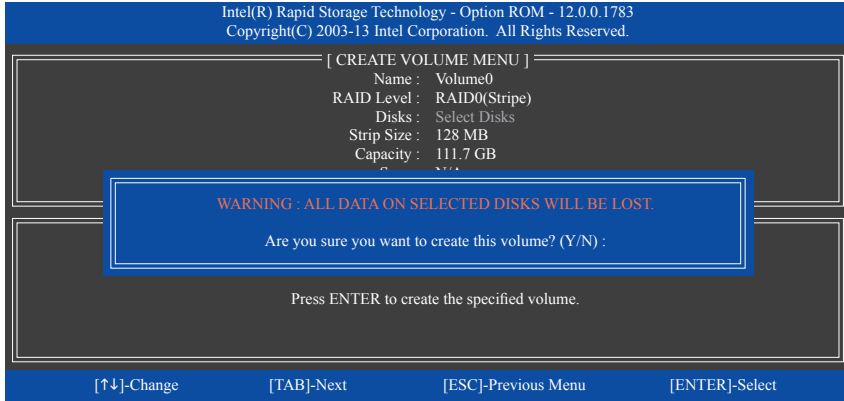

Figure 13

When completed, you can see detailed information about the RAID array in the **DISK/VOLUME INFORMATION** section, including the RAID level, stripe block size, array name, and array capacity, etc. (Figure 14)

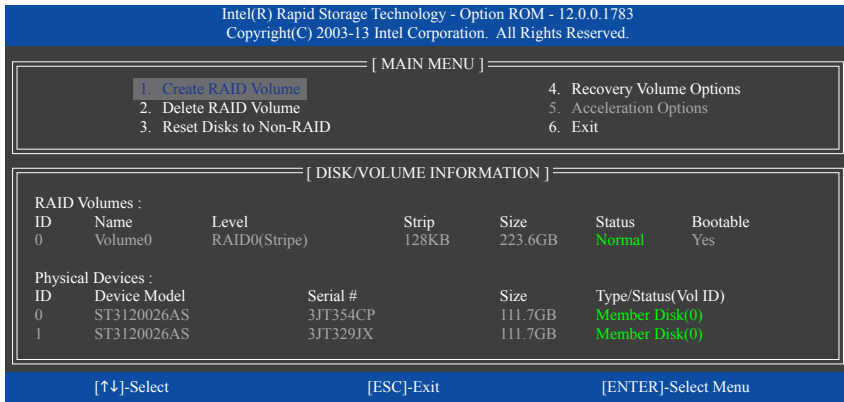

Figure 14

To exit the RAID BIOS utility, press <Esc> or select **6. Exit** in **MAIN MENU**.

Now, you can proceed to install the SATA RAID/AHCI driver and operating system.

## Recovery Volume Options

Intel® Rapid Recover Technology provides data protection by allowing users to easily restore data and system operation using a designated recovery drive. With the Rapid Recovery Technology, which employs RAID 1 functionality, users can copy the data from the master drive to the recovery drive; if needed, the data on the recovery drive can be restored back to the master drive.

Before you begin:

- The recovery drive must have equal or greater capacity than the master drive.
- A recovery volume can be created with two hard drives only. A recovery volume and a RAID array cannot co-exist in the system at the same time, that is, if you have already created a recovery volume, you are unable to create a RAID array.
- By default, only the master drive can be viewed in the operating system; the recovery drive is hidden.

Step 1:

Select **Create RAID Volume** in **MAIN MENU** and press <Enter> (Figure 15).

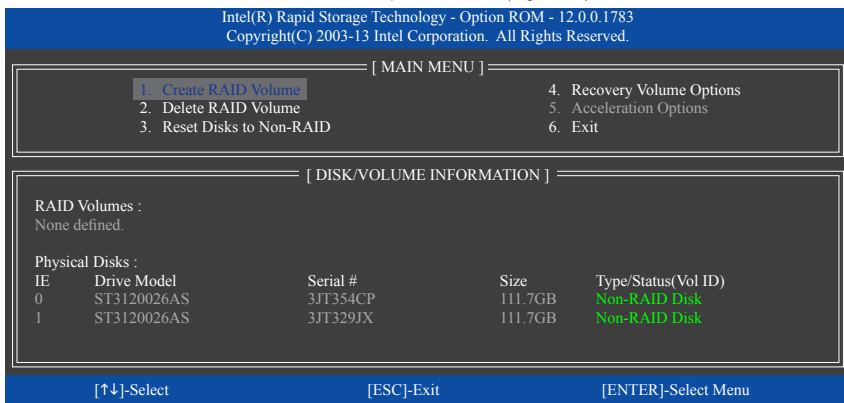

Figure 15

Step 2:

After entering the volume name, select **Recovery** under the **RAID Level** item and press <Enter> (Figure 16).

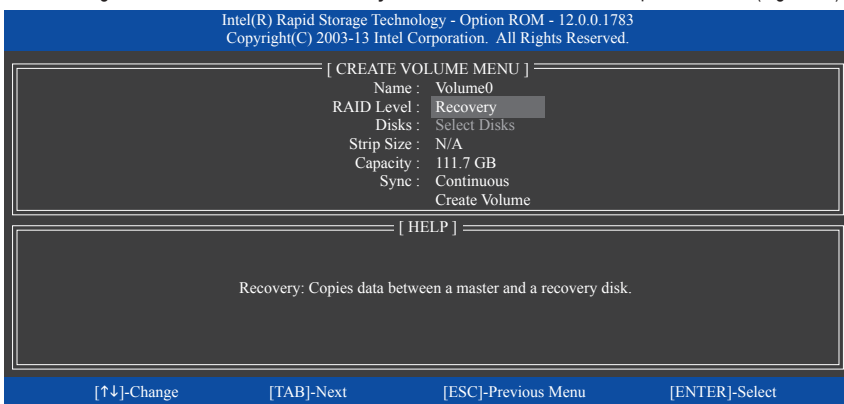

Figure 16

Step 3:

Press <Enter> under the **Select Disks** item. In the **SELECT DISKS** box, press <Tab> on the hard drive you want to use for the master drive and press <Space> on the hard drive you want to use for the recovery drive. (Make sure the recovery drive has equal or larger capacity than the master drive.) Then press <Enter> to confirm (Figure 17).

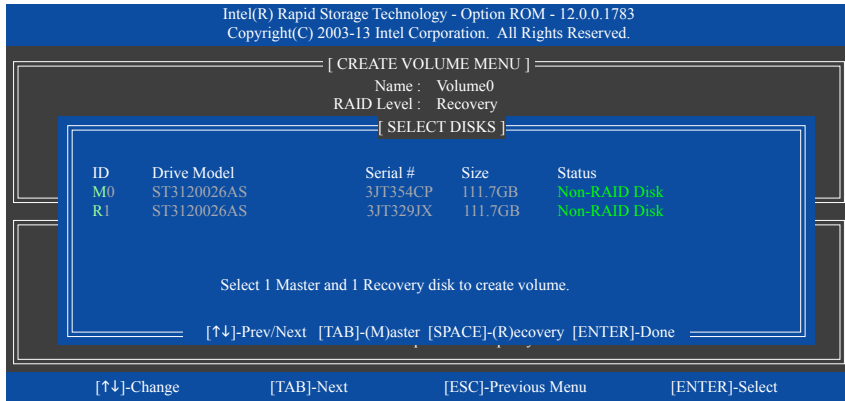

Figure 17

Step 4:

Under **Sync**, select **Continuous** or **On Request** (Figure 18). When set to **Continuous**, changes made to the data on the master drive will be automatically and continuously copied to the recovery drive when both hard drives are installed in the system. **On Request** allows users to update data from the master drive to the recovery drive manually using the Intel® Rapid Storage Technology utility in the operating system. **On Request** also allows users to restore the master drive to a previous state.

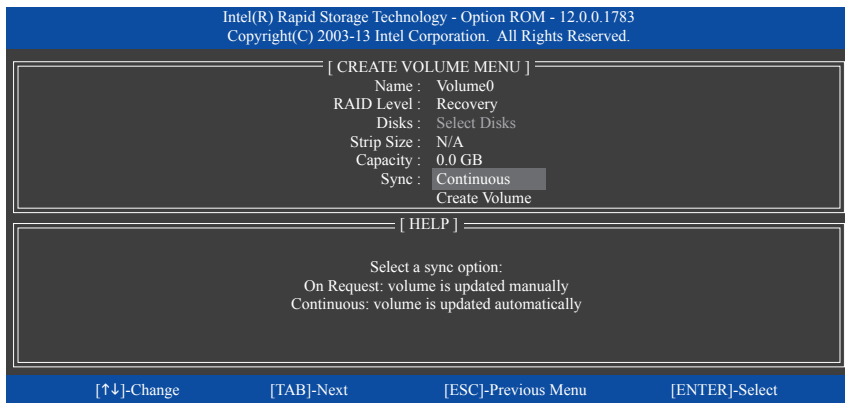

Figure 18

Step 5:

Finally press <Enter> on the **Create Volume** item to begin creating the Recovery Volume and follow the on-screen instructions to complete.

### Delete RAID Volume

To delete a RAID array, select **Delete RAID Volume** in **MAIN MENU** and press <Enter>. In the **DELETE VOLUME MENU** section, use the up or down arrow key to select the array to be deleted and press <Delete>. When prompted to confirm your selection (Figure 19), press <Y> to confirm or <N> to abort.

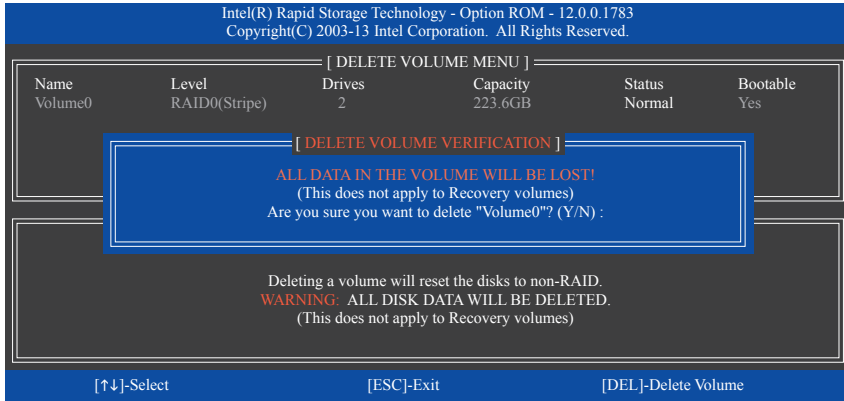

Figure 19

### Acceleration Options

This option allows you to view the status of your accelerated drive/volume (Figure 20) created using the Intel® IRST utility. In case you are unable to run the Intel® IRST utility due to an application error or operating system issue, you will need to remove acceleration or manually enable synchronization (Maximized mode only) using this option in the RAID ROM utility.

Steps:

Select **Acceleration Options** in **MAIN MENU** and press <Enter>.

To remove the acceleration, select the accelerated drive/volume, press <R>, and press <Y> to confirm.

To synchronize data from the cache device to the accelerated drive/volume, press <S> and press <Y> to confirm.

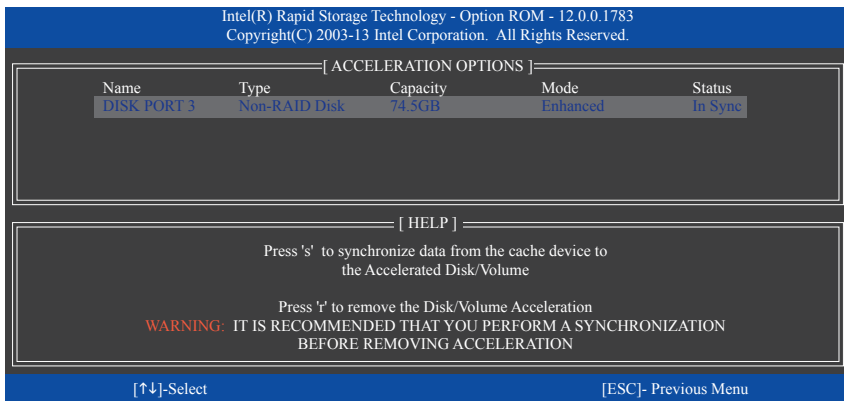

Figure 20



## 3-2 Installing the SATA RAID/AHCI Driver and Operating System

With the correct BIOS settings, you are ready to install Windows 8/7.

### A. Installing Windows 8/7

As Windows 7 already include Intel® SATA RAID/AHCI driver, you do not need to install separate RAID/AHCI driver during the Windows installation process. After the operating system is installed, we recommend that you install all required drivers from the motherboard driver disk using "Xpress Install" to ensure system performance and compatibility. To install Windows 8, refer to the steps below:

Step 1:

Copy the **IRST** folder under **BootDrv** in the driver disk to your USB thumb drive.

Step 2:

Boot from the Windows 8 setup disk and perform standard OS installation steps. When the screen requesting you to load the driver appears, select **Browse**.

Step 3:

Insert the USB thumb drive and then browse to the location of the driver. The locations of the drivers are as follows:

Windows 32-bit: \IRST\32Bit

Windows 64-bit: \IRST\64Bit

Step 4:

When a screen as shown in Figure 1 appears, select **Intel(R) Desktop/Workstation/Server Express Chipset SATA RAID Controller (G:\IRST\32Bit\iAstorAC.inf)** and click **Next** to load the driver and continue the OS installation.

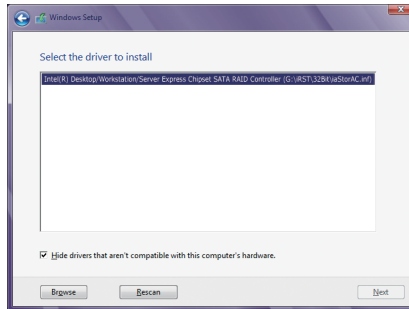

Figure 1

## B. Rebuilding an Array

Rebuilding is the process of restoring data to a hard drive from other drives in the array. Rebuilding applies only to fault-tolerant arrays such as RAID 1, RAID 5 or RAID 10 arrays. The procedures below assume a new drive is added to replace a failed drive to rebuild a RAID 1 array. (Note: The new drive must have equal or greater capacity than the old one.)

Turn off your computer and replace the failed hard drive with a new one. Restart your computer.

### • Enabling Automatic Rebuild

Step 1:

When the message "Press <Ctrl-> to enter Configuration Utility" appears, press <Ctrl> + <I> to enter the RAID Configuration Utility. The following screen appears after you enter the RAID Configuration Utility.

Intel(R) Rapid Storage Technology - Option ROM - 12.0.0.1783  
Copyright(C) 2003-13 Intel Corporation. All Rights Reserved.

[ MAIN MENU ]

[ DEGRADED VOLUME DETECTED ]

"Degraded volume and disk available for rebuilding detected. Selecting a disk initiates a rebuild. Rebuild completes in the operating system.

Select the port of the destination disk for rebuilding (ESC to exit):

ID	Drive Model	Serial #	Size
1	WDC WD800JD-22LS	WD-WMAM9W736333	111.7GB

[↑↓]-Previous/Next      [ENTER]-Select      [ESC]-Exit

RAID ID	Devices Model	Serial #	Size	Type/Status(Vol ID)
0	ST3120026AS	3JT354CP	111.7GB	Member Disk (0)
1	WDC WD800JD-22LS	WD-WMAM9W736333	111.7GB	Non-RAID Disk

[↑↓]-Select      [ESC]-Exit      [ENTER]-Select Menu

Step 2:

Select the new hard drive to add into the array to be rebuilt and press <Enter>. The following screen appears, indicating that an automatic rebuild will be performed after you enter the operating system. If you do not enable automatic rebuild on this stage, you have to manually rebuild the array in the operating system (see the next page for more details).

Intel(R) Rapid Storage Technology - Option ROM - 12.0.0.1783  
Copyright(C) 2003-13 Intel Corporation. All Rights Reserved.

[ MAIN MENU ]

1. Create RAID Volume
2. Delete RAID Volume
3. Reset Disks to Non-RAID
4. Recovery Volume Options
5. Acceleration Options
6. Exit

[ DISK/VOLUME INFORMATION ]

RAID Volumes :	ID	Name	Level	Strip	Size	Status	Bootable
	0	Volume0	RAID1(Mirror)	N/A	111.7GB	Rebuild	Yes

Physical Devices :	ID	Devices Model	Serial #	Size	Type/Status(Vol ID)
	0	ST3120026AS	3JT354CP	111.7GB	Member Disk (0)
	1	WDC WD800JD-22LS	WD-WMAM9W736333	111.7GB	Member Disk (0)

Volumes with "Rebuild" status will be rebuilt within the operating system.

[↑↓]-Select      [ESC]-Exit      [ENTER]-Select Menu

- **Performing the Rebuild in the Operating System**

While in the operating system, make sure the chipset driver has been installed from the motherboard driver disk. Then launch the Intel® Rapid Storage Technology utility from the desktop.

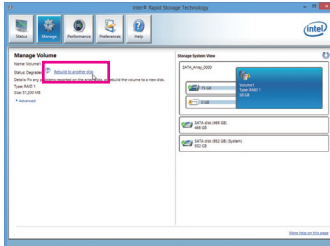

Step 1:

Go to the **Manage** menu and click **Rebuild to another disk in Manage Volume**.

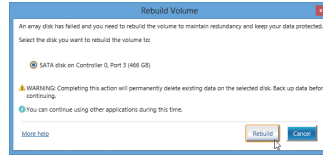

Step 2:

Select a new drive to rebuild the RAID and click **Rebuild**.

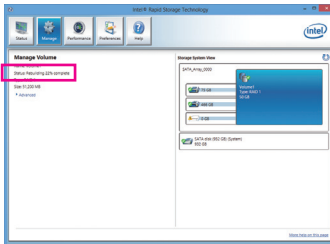

The **Status** item on the left of the screen displays the rebuild progress.

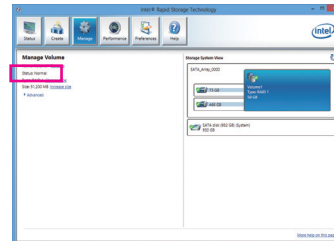

Step 3:

After the RAID 1 volume rebuilding, the **Status** will display as **Normal**.

- **Restoring the Master Drive to a Previous State (for Recovery Volume only)**

When two hard drives are set to Recovery Volume in Update on Request mode, you can restore the master drive data to the last backup state when needed. For example, in case the master drive detects a virus, you can restore the recovery drive data to the master drive.

Step 1:

Select **4. Recovery Volume Options** in the **MAIN MENU** of the Intel® RAID Configuration Utility. On the **RECOVERY VOLUMES OPTIONS** menu, select **Enable Only Recovery Disk** to show the recovery drive in the operating system. Follow the on-screen instructions to complete and exit the RAID Configuration Utility.

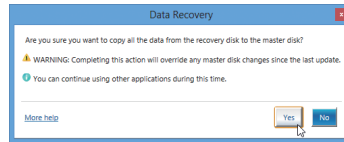
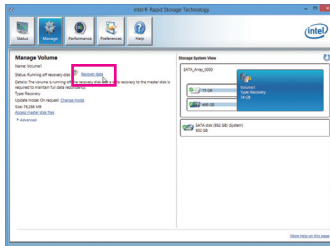
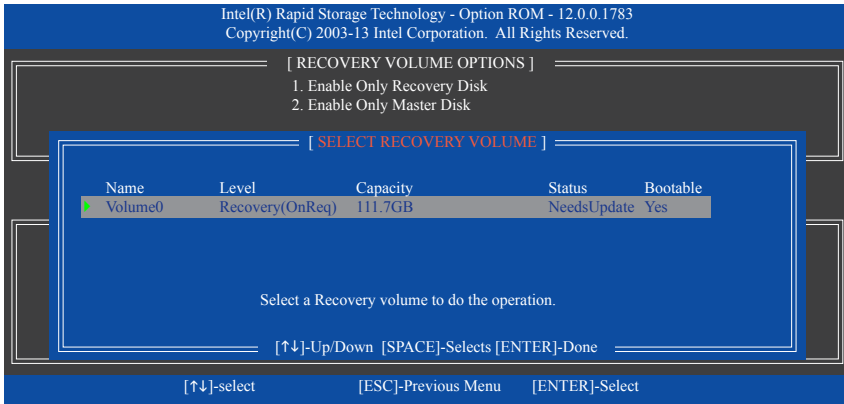

Step 3:  
Click **Yes** to begin the data recovery.

Step 2:

Go to the **Manage** menu of the Intel® Rapid Storage Technology utility and click **Recover data** in **Manage Volume**.

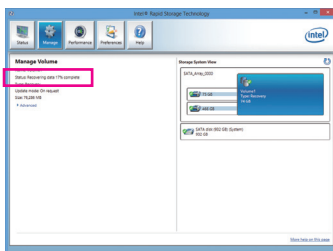

The **Status** item on the left of the screen displays the rebuild progress.

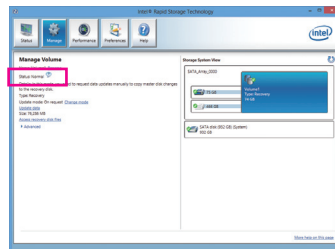

Step 4:  
After the recovery volume is completed, the **Status** will display as **Normal**.

## Chapter 4 Drivers Installation



- Before installing the drivers, first install the operating system. (The following instructions use Windows 8 as the example operating system.)
- After installing the operating system, insert the motherboard driver disk into your optical drive. Click on the message "Tap to choose what happens with this disc" on the top-right corner of the screen and select "Run Run.exe." (Or go to My Computer, double-click the optical drive and execute the Run.exe program.)

### 4-1 Chipset Drivers

"Xpress Install" will automatically scan your system and then list all of the drivers that are recommended to install. You can click the **Xpress Install** button and "Xpress Install" will install all of the selected drivers. Or click the arrow  icon to individually install the drivers you need.

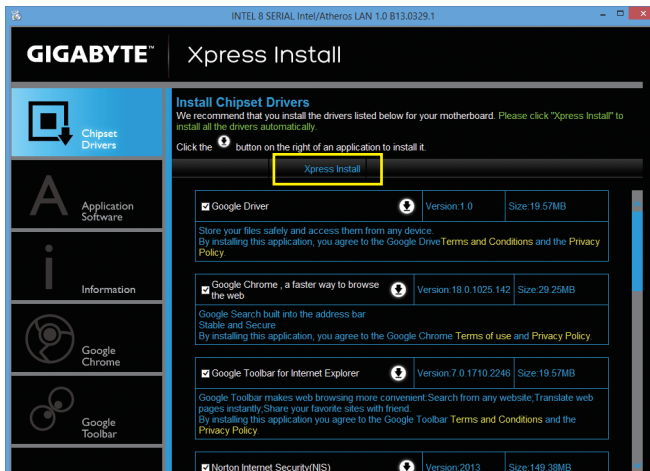

- Please ignore the popup dialog box(es) (e.g. the **Found New Hardware Wizard**) displayed when "Xpress Install" is installing the drivers. Failure to do so may affect the driver installation.
- Some device drivers will restart your system automatically during the driver installation. After the system restart, "Xpress Install" will continue to install other drivers.

## 4-2 Application Software

This page displays the apps that GIGABYTE develops and some free software. You can select the apps you want and click the **Install**  icon to begin the installation.

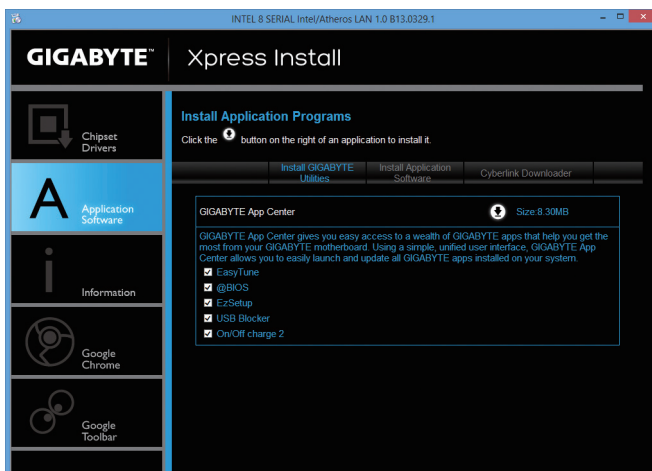

## 4-3 Information

This page provides detailed information on the drivers on the driver disk. The **Contact** page provides contact information of the GIGABYTE Taiwan headquarter. You can click the URL on this page to link to the GIGABYTE website to check more information on the GIGABYTE headquarter or worldwide branch offices.

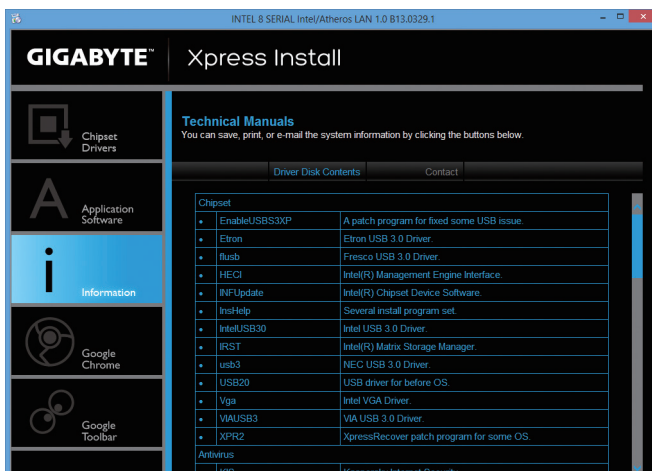

## Chapter 5 Unique Features

### 5-1 BIOS Update Utilities

GIGABYTE motherboards provide two unique BIOS update tools, Q-Flash™ and @BIOS™. GIGABYTE Q-Flash and @BIOS are easy-to-use and allow you to update the BIOS without the need to enter MS-DOS mode. Additionally, this motherboard features the DualBIOS™ design, which enhances protection for the safety and stability of your computer by adding one more physical BIOS chip.

#### What is DualBIOS™?

Motherboards that support DualBIOS have two BIOS onboard, a main BIOS and a backup BIOS. Normally, the system works on the main BIOS. However, if the main BIOS is corrupted or damaged, the backup BIOS will take over on the next system boot and copy the BIOS file to the main BIOS to ensure normal system operation. For the sake of system safety, users cannot update the backup BIOS manually.

#### What is Q-Flash™?

With Q-Flash you can update the system BIOS without having to enter operating systems like MS-DOS or Windows first. Embedded in the BIOS, the Q-Flash tool frees you from the hassles of going through complicated BIOS flashing process.

#### What is @BIOS™?

@BIOS allows you to update the system BIOS while in the Windows environment. @BIOS will download the latest BIOS file from the nearest @BIOS server site and update the BIOS.

### 5-1-1 Updating the BIOS with the Q-Flash Utility

#### A. Before You Begin

1. From GIGABYTE's website, download the latest compressed BIOS update file that matches your motherboard model.
2. Extract the file and save the new BIOS file (e.g. Z87HD3.F1) to your USB flash drive or hard drive. Note: The USB flash drive or hard drive must use FAT32/16/12 file system.
3. Restart the system. During the POST, press the <End> key to enter Q-Flash. Note: You can access Q-Flash by either pressing the <End> key during the POST or pressing the <F8> key in BIOS Setup. However, if the BIOS update file is saved to a hard drive in RAID/AHCI mode or a hard drive attached to an independent SATA controller, use the <End> key during the POST to access Q-Flash.



Because BIOS flashing is potentially risky, please do it with caution. Inadequate BIOS flashing may result in system malfunction.

## B. Updating the BIOS

In the main menu of Q-Flash, use the keyboard or mouse to select an item to execute. When updating the BIOS, choose the location where the BIOS file is saved. The following procedure assumes that you save the BIOS file to a USB flash drive.

Step 1:

1. Insert the USB flash drive containing the BIOS file into the computer. In the main menu of Q-Flash, select **Update BIOS From Drive**.



- The **Save BIOS to Drive** option allows you to save the current BIOS file.
- Q-Flash only supports USB flash drive or hard drives using FAT32/16/12 file system.
- If the BIOS update file is saved to a hard drive in RAID/AHCI mode or a hard drive attached to an independent SATA controller, use the <End> key during the POST to access Q-Flash.

2. Select **USB Flash Drive**.

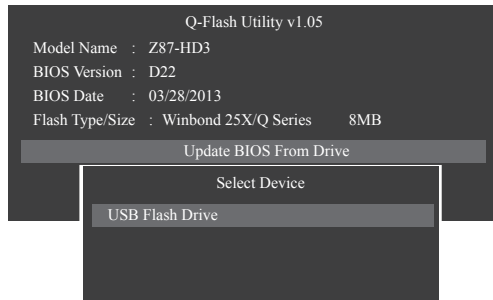

3. Select the BIOS update file.



**Make sure the BIOS update file matches your motherboard model.**

Step 2:

The process of the system reading the BIOS file from the USB flash drive is displayed on the screen. When the message "Are you sure to update BIOS?" appears, select **Yes** to begin the BIOS update. The monitor will display the update process.



- **Do not turn off or restart the system when the system is reading/updating the BIOS.**
- **Do not remove the USB flash drive or hard drive when the system is updating the BIOS.**

Step 3:

The system will restart after the update process is complete.



**Step 4:**

During the POST, press <Delete> to enter BIOS Setup. Select **Load Optimized Defaults** on the **Save & Exit** screen and press <Enter> to load BIOS defaults. System will re-detect all peripheral devices after a BIOS update, so we recommend that you reload BIOS defaults.



Select **Yes** to load BIOS defaults

**Step 5:**

Select **Save & Exit Setup** and press <Enter>. And then select **Yes** to save settings to CMOS and exit BIOS Setup. The procedure is complete after the system restarts.

## 5-1-2 Updating the BIOS with the @BIOS Utility

### A. Before You Begin

1. In Windows, close all applications and TSR (Terminate and Stay Resident) programs. This helps prevent unexpected failures when performing a BIOS update.
2. If the BIOS is being updated via the Internet, ensure the Internet connection is stable and do NOT interrupt the Internet connection (for example, avoid a power loss or switching off the Internet). Failure to do so may result in a corrupted BIOS or a system that is unable to start.
3. GIGABYTE product warranty does not cover any BIOS damage or system failure resulting from an inadequate BIOS flashing.

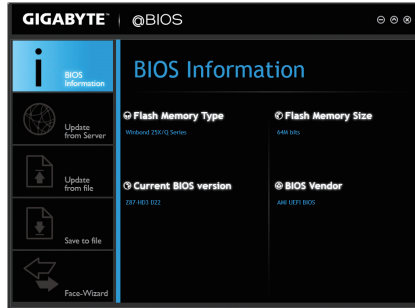

### B. Using @BIOS

#### 1. Update the BIOS Using the Internet Update Function:



Click **Update from Server**, select the @BIOS server site closest to your location and then download the BIOS file that matches your motherboard model. Follow the on-screen instructions to complete.



If the BIOS update file for your motherboard is not present on the @BIOS server site, please manually download the BIOS update file from GIGABYTE's website and follow the instructions in "Update the BIOS without Using the Internet Update Function" below.

#### 2. Update the BIOS without Using the Internet Update Function:



Click **Update from file**, then select the location where you save the BIOS update file obtained from the Internet or through other source. Follow the on-screen instructions to complete.

#### 3. Save the Current BIOS File:



Click **Save to file** to save the current BIOS file.

#### 4. Change the Boot-up Logo:



Click **Upload new image** in Face-Wizard and you will be able to change the boot-up logo with your own picture, creating a personalized boot-up screen. Click **Backup current image** to save the currently used boot-up logo.



Supported image formats include jpg, bmp, and gif.

### C. After Updating the BIOS

Restart your system after updating the BIOS.



- Make sure that the BIOS file to be flashed matches your motherboard model. Updating the BIOS with an incorrect BIOS file could cause your system not to boot.
- Do not turn off the system or remove the power during the BIOS update process, or the BIOS may corrupt and the system may not boot.

## 5-2 APP Center

GIGABYTE App Center gives you easy access to a wealth of GIGABYTE apps that help you get the most from your GIGABYTE motherboard <sup>(Note)</sup>. Using a simple, unified user interface, GIGABYTE App Center allows you to easily launch all GIGABYTE apps installed on your system, check related updates online, and download the apps, drivers, and BIOS.

### Running the APP Center

Insert the motherboard driver disk. On the Autorun screen, go to **Application Software** Install **GIGABYTE Utilities** to install GIGABYTE App Center and the selected apps. Restart your computer after the installation is complete. In Desktop mode, click the App Center icon  in the notification area to launch the App Center utility (Figure 1). On the main menu, you can select an app to run or click **Live Update** to update an app online.

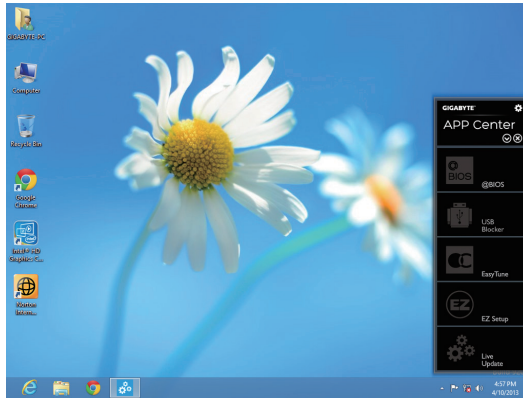

Figure 1

If the App Center is closed, you can restart it by clicking the App Center icon on the Start menu. (Figure 2)

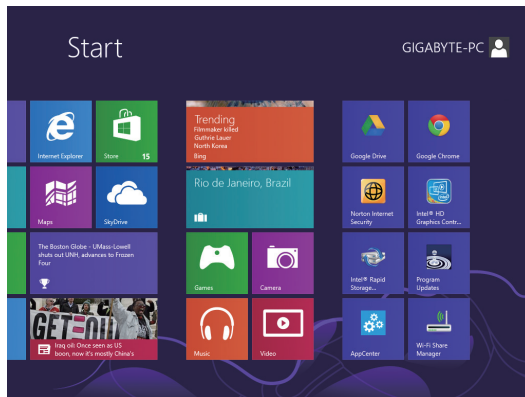

Figure 2

(Note) Available applications in APP Center may differ by motherboard model. Supported functions of each application may also differ depending on motherboard specifications.



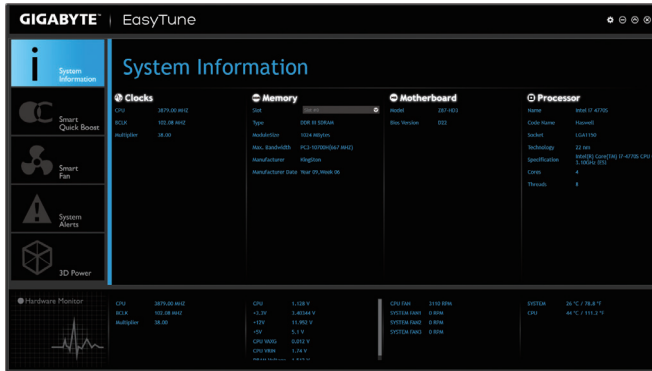

## 5-2-1 EasyTune

GIGABYTE's EasyTune is a simple and easy-to-use interface that allows users to fine-tune their system settings or do overclock/overvoltage in Windows environment. The user-friendly EasyTune interface also includes tabbed pages for CPU and memory information, letting users read their system-related information without the need to install additional software.

### The EasyTune Interface



### Tabs Information

Tab	Function
	The <b>System Information</b> tab provides information on the installed CPU and motherboard.
	<b>Smart Quick Boost</b> provides you with different levels of CPU frequency to choose to achieve desired system performance. After making changes, be sure to restart your system for these changes to take effect. The Advanced menu allows you to change specific clock/frequency/voltage settings.
	The <b>Smart Fan</b> tab allows you to specify a Smart Fan mode. The Calibrate menu displays the detected linear fan speed for the fans on the motherboard from the fastest to the slowest. The Advanced menu allows you to set temperature thresholds, based on which the fan speed can be changed linearly.
	The <b>System Alerts</b> tab allows you to monitor hardware temperature, voltage and fan speed and set temperature/fan speed alarm.
	The <b>3D Power</b> tab allows you to change power phase and voltage settings.



Available functions in EasyTune may differ by motherboard model. Grayed-out area(s) indicates that the item is not configurable or the function is not supported.



Incorrectly doing overclock/overvoltage may result in damage to the hardware components such as CPU, chipset, and memory and reduce the useful life of these components. Before you do the overclock/overvoltage, make sure that you fully know each function of EasyTune, or system instability or other unexpected results may occur.

## 5-2-2 EZ Setup

The GIGABYTE EZ Setup utility includes the following 'EZ' setups applications that will offer greatly simplified install and configuration procedures: Disk Mode Switch, EZ Smart Response, EZ Rapid Start, EZ Smart Connect, and XHD.

### Disk Mode Switch

Disk Mode Switch allows you to switch the operating mode for your hard drive even after it's been installed with an operating system. Supported operating modes include IDE, AHCI, and RAID. You can select a disk mode and restart your computer after the selection.



- Native UEFI mode is not supported.
- Be sure to reinstall the Intel® Rapid Storage Technology utility after you switch the disk mode.

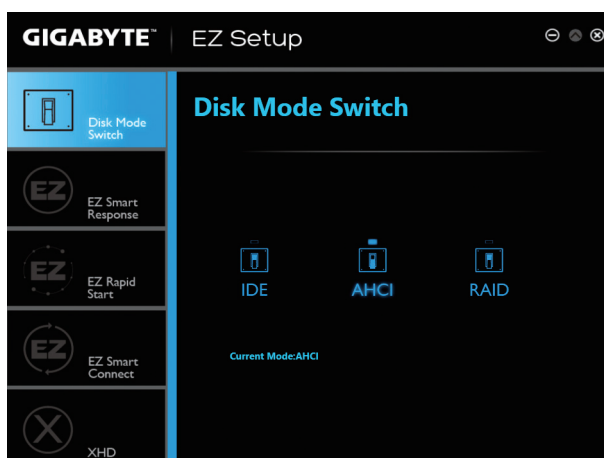

## EZ Smart Response

### A. System Requirements

1. An Intel® Chipset-based motherboard supporting this feature <sup>(Note 1)</sup>
2. Intel® Core series processor
3. Intel® SATA controller set to RAID mode
4. Intel® Rapid Storage Technology utility installed <sup>(Note 1)</sup>
5. A conventional SATA disk and an SSD <sup>(Note 2)</sup>
6. Windows 7 with SP1/Windows 8 <sup>(Note 3)</sup>



If you have installed the operating system before configuring the Smart Response Technology, all original data on the SSD will be lost once you enable RAID mode. It is recommended that you back up the hard disk before enabling the Smart Response Technology.

### B. Using EZ Smart Response

Select **EZ Smart Response** and click **Create**.

To disable this function, click **Delete**.

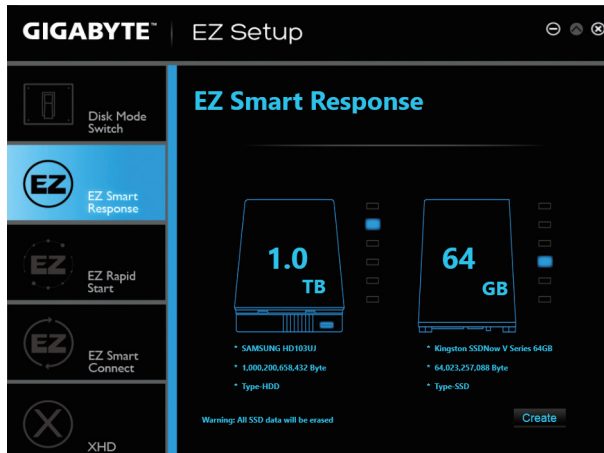

(Note 1) Before start, make sure you have installed the Intel® Rapid Storage Technology utility (version 11.5 or above).

(Note 2) The SSD works as a cache of the hard disk. The maximum cache memory size is 64 GB. If you use an SSD larger than 64 GB, the space beyond 64 GB can still be used for storing your data.

(Note 3) The operating system must be installed to the SATA disk.

(Note 4) Regardless of the BIOS settings, be it IDE or AHCI mode, the system will be forced into RAID mode.

## EZ Rapid Start

### A. System Requirements

1. Intel® Rapid Start Technology enabled in BIOS Setup
2. An SSD with size larger than the total system memory
3. Windows 7 with SP1/Windows 8
4. AHCI/RAID mode supported (please note if the SSD has been assigned as a member of a RAID array, it cannot be used to set up and Intel® Rapid Start store partition); IDE mode not supported

### B. Using EZ Rapid Start

Select **EZ Rapid Start** and click **Create**. Then install the Intel® Rapid Start Technology utility and restart your computer to complete.

To disable this function, click **Delete**.

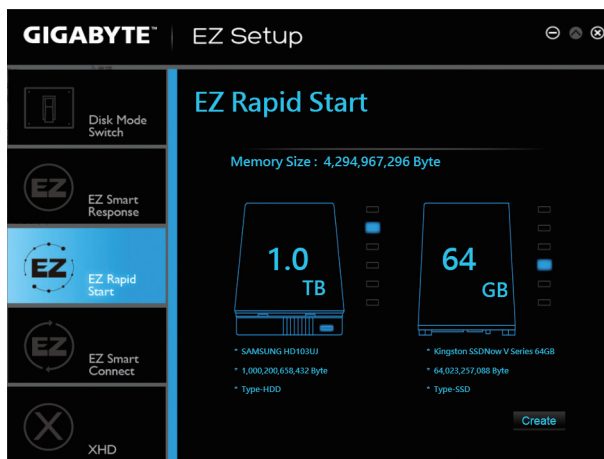

- The default compressed space is the system memory size plus 2 GB. For example, if the system memory size is 8 GB, the default compressed space is 8 GB plus 2 GB, so the SSD capacity will decrease by 10 GB. If EZ Rapid Start is disabled, the decreased 10 GB will be returned to the SSD.
- If you want to upgrade your system memory, disable EZ Rapid Start first and re-install it to ensure it can work normally.

(Note) If the motherboard Chipset supports RAID, EZ Rapid Start will force the Intel® SATA controllers into RAID mode. If not, the Intel® SATA controllers will be forced into AHCI mode.

## EZ Smart Connect

### A. System Requirements

1. Intel® Smart Connect Technology enabled in BIOS Setup
2. Windows 7 with SP1/Windows 8
3. Intel® Smart Connect Technology utility installed
4. Properly-working network connection
5. Programs added to the White List must be turned on

### B. Using EZ Smart Connect

Select **EZ Smart Connect**. Under **File name**, select the apps to be auto-updated by Smart Connect. Double-click the app to add it to the **White list file name** list. (Double-click  to return to the previous directory.)

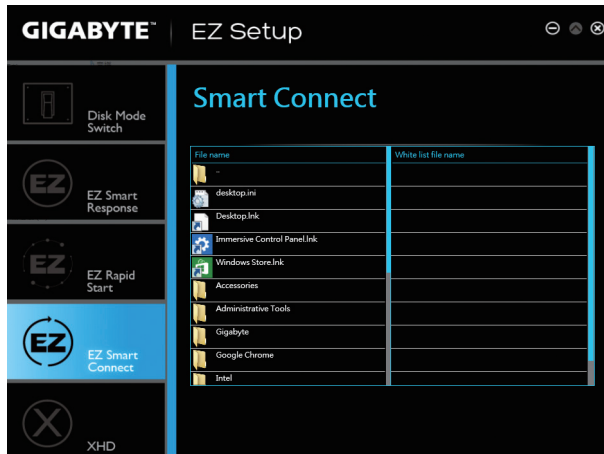

(Note) This feature works best with programs designed to work automatically with the Internet to obtain their data such as Outlook®, Windows Live™ Mail, and Seesmic®.



## XHD

With GIGABYTE XHD <sup>(Note 1)</sup>, users can quickly configure a RAID-ready system for RAID 0 or RAID 1 when a new SATA drive is added. All with a simple click of a button, XHD helps to enhance your hard drive read/write performance without the need for complex and time-consuming configurations. .

### A. System Requirements

1. An Intel® Chipset motherboard supporting RAID
2. Intel® SATA controllers set to RAID mode
3. Intel® Rapid Storage Technology utility installed
4. Windows 7 with SP1/Windows 8
5. Intel® SATA controller driver installed

### B. Using XHD

Select **XHD** and click **Create Raid 0** or **Create Raid 1** based on your need. <sup>(Note 2)</sup>

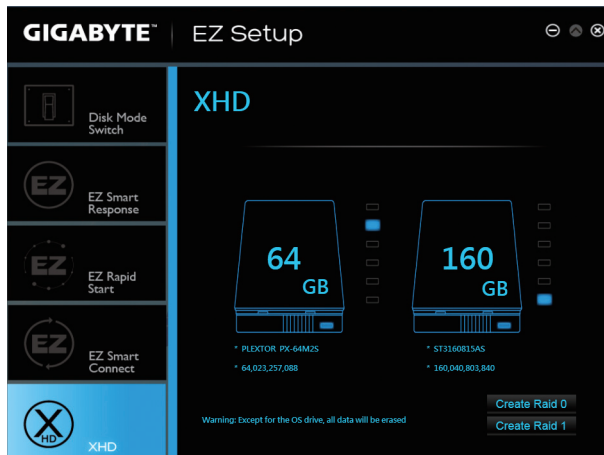

(Note 1) The XHD utility only supports the SATA connectors controlled by the Intel® Chipset.

(Note 2) Except for the operating system drive, all data on other hard drive will be deleted. Back up your data before using the XHD utility.

### 5-2-3 USB Blocker

GIGABYTE USB Blocker provides you with an easy-to-use interface that allows you to block certain USB device types on your PC. Devices classes that are blocked will be ignored by the operating system.

#### The USB Blocker Interface

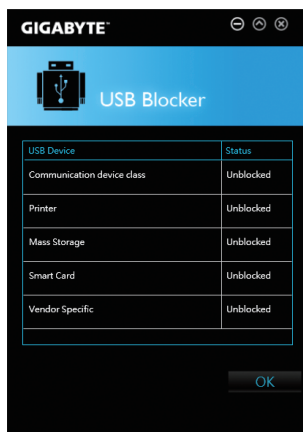

#### Using USB Blocker

Select the class of USB device that you would like to block or unblocked. Double left-click to change the **Blocked** or **Unblocked** status and click **OK**. Then enter your password and click **OK** to complete.

# Chapter 6 Appendix

## 6-1 Configuring Audio Input and Output

### 6-1-1 Configuring 2/4/5.1/7.1-Channel Audio

The motherboard provides six audio jacks on the back panel which support 2/4/5.1/7.1-channel (Note) audio. The picture to the right shows the default audio jack assignments.



The integrated HD (High Definition) audio provides jack retasking capability that allows the user to change the function for each jack through the audio driver. (Supported functions for each jack may vary based on hardware specification.)

For example, in a 4-channel audio configuration, if a Rear speaker is plugged into the default Center/Subwoofer speaker out jack, you can retask the Center/Subwoofer speaker out jack to be Rear speaker out.



- To install a microphone, connect your microphone to the Mic in jack and manually configure the jack for microphone functionality.
- Audio signals will be present on both of the front and back panel audio connections simultaneously. If you want to mute the back panel audio (only supported when using an HD front panel audio module), refer to instructions on the next page.

#### High Definition Audio (HD Audio)

HD Audio includes multiple high quality digital-to-analog converters (DACs). HD Audio features multistreaming capabilities that allow multiple audio streams (in and out) to be simultaneously processed. For example, users can listen to MP3 music, have an Internet chat, make a telephone call over the Internet, and etc. all at the same time.

### A. Configuring Speakers

(The following instructions use Windows 8 as the example operating system.)

Step 1:

After installing the audio driver, the **HD Audio Manager** icon  will appear in the notification area. Double-click the icon to access the **HD Audio Manager**.

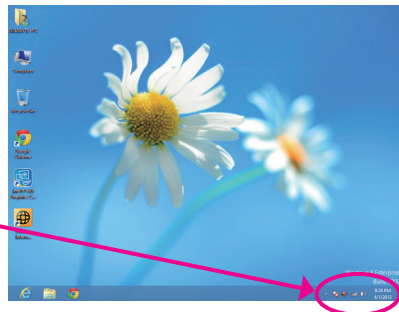

(Note) 2/4/5.1/7.1-Channel Audio Configurations:

Refer to the following for multi-channel speaker configurations.

- 2-channel audio: Headphone or Line out.
- 4-channel audio: Front speaker out and Rear speaker out.
- 5.1-channel audio: Front speaker out, Rear speaker out, and Center/Subwoofer speaker out.
- 7.1-channel audio: Front speaker out, Rear speaker out, Center/Subwoofer speaker out, and Side speaker out.

**Step 2:**

Connect an audio device to an audio jack. The **The current connected device is** dialog box appears. Select the device according to the type of device you connect. Then click **OK**.

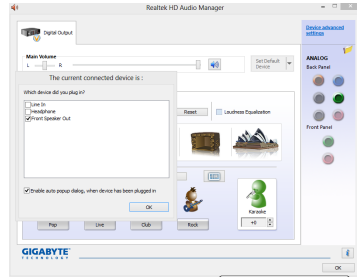

**Step 3:**

On the **Speakers** screen, click the **Speaker Configuration** tab. In the **Speaker Configuration** list, select **Stereo**, **Quadraphonic**, **5.1 Speaker**, or **7.1 Speaker** according to the type of speaker configuration you wish to set up. Then the speaker setup is completed.

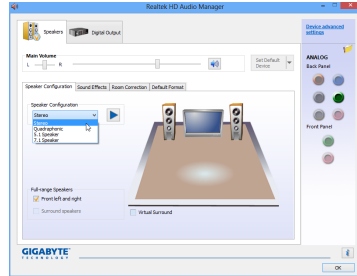

**B. Configuring Sound Effect**

You may configure an audio environment on the **Sound Effects** tab.

**C. Activating an AC'97 Front Panel Audio Module**

If your chassis provides an AC'97 front panel audio module, to activate the AC'97 functionality, click the tool icon on the **Speaker Configuration** tab. On the **Connector Settings** dialog box, select the **Disable front panel jack detection** check box. Click **OK** to complete.

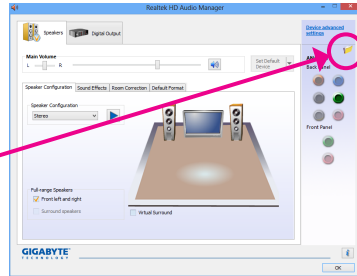
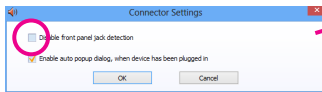

**D. Muting the Back Panel Audio (For HD Audio Only)**

Click **Device advanced settings** on the top right corner on the **Speaker Configuration** tab to open the **Device advanced settings** dialog box. Select the **Mute the rear output device, when a front headphone plugged in** check box. Click **OK** to complete.

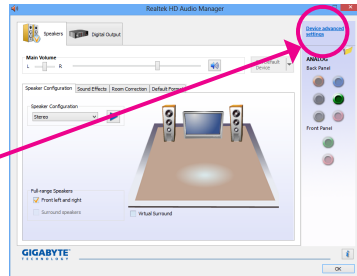
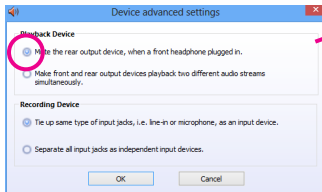

## 6-1-2 Configuring S/PDIF Out

The S/PDIF Out jack can transmit audio signals to an external decoder for decoding to get the best audio quality.

### Configuring S/PDIF Out:

On the **Digital Output** screen, click the **Default Format** tab and then select the sample rate and bit depth. Click **OK** to complete.

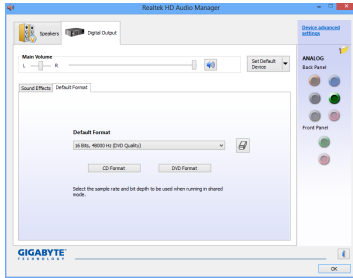

## 6-1-3 Configuring Microphone Recording

Step 1:

After installing the audio driver, the **HD Audio Manager** icon  will appear in the notification area. Double-click the icon to access the **HD Audio Manager**.

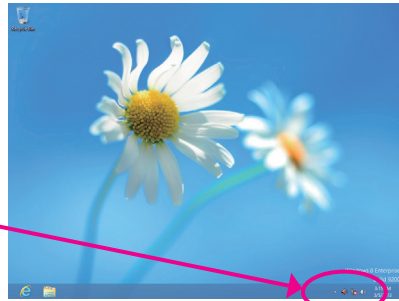

Step 2:

Connect your microphone to the Mic in jack (pink) on the back panel or the Mic in jack (pink) on the front panel. Then configure the jack for microphone functionality.

Note: The microphone functions on the front panel and back panel cannot be used at the same time.

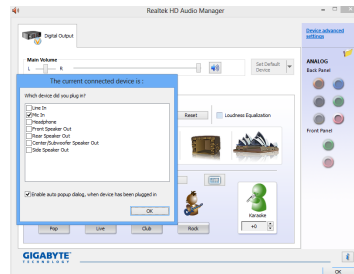

Step 3:

Go to the **Microphone** screen. Do not mute the recording volume, or you'll not be able to record the sound. To hear the sound being recorded during the recording process, do not mute the playback volume. It is recommended that you set the volumes at a middle level.

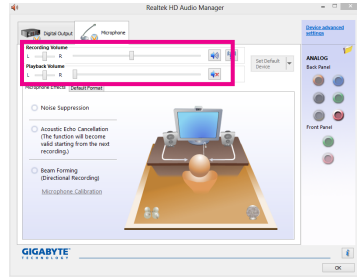

Step 4:

To raise the recording and playback volume for the microphone, click the **Microphone Boost** icon on the right of the **Recording Volume** slider and set the Microphone Boost level.

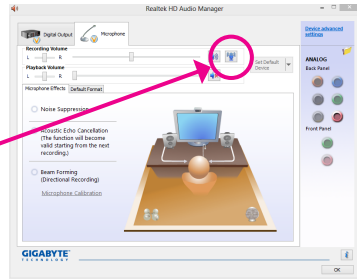
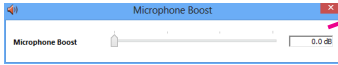

Step 5:

To open the **Sounder Recorder**, move the mouse cursor to the bottom left corner of the screen, click the **Start** icon to switch to the **Start** screen (or press the Windows button on the keyboard). Right-click on the screen and click the **All apps** icon on the bottom right corner of the screen to access the **Apps** screen

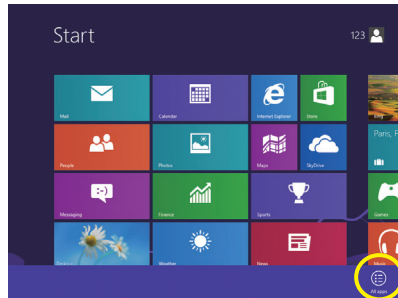

Step 6:

On this screen, click **Sound Recorder** for audio recording.

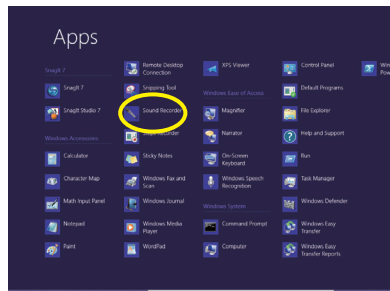

### \* Enabling Stereo Mix

If the HD Audio Manager does not display the recording device you wish to use, refer to the steps below. The following steps explain how to enable Stereo Mix (which may be needed when you want to record sound from your computer).

Step 1:

Locate the  icon in the notification area and right-click on this icon. Select **Recording Devices**.

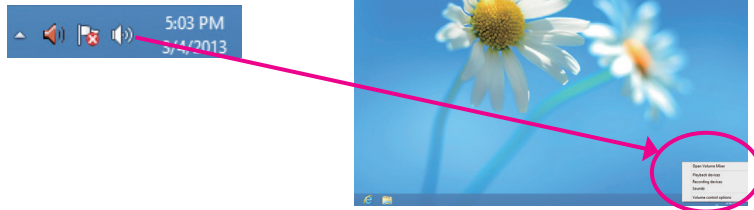

Step 2:

On the **Recording** tab, right-click on an empty space and select **Show Disabled Devices**.

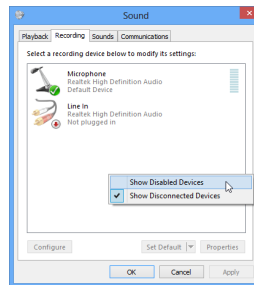

Step 3:

When the **Stereo Mix** item appears, right-click on this item and select **Enable**. Then set it as the default device.

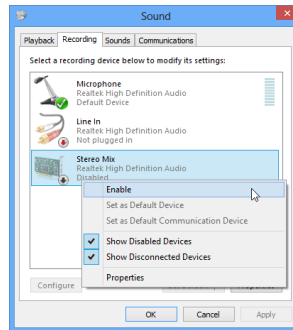

Step 4:

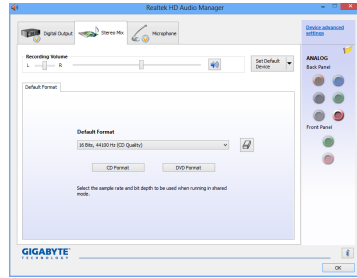

Now you can access the **HD Audio Manager** to configure **Stereo Mix** and use **Sound Recorder** to record the sound.

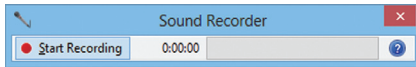

## 6-1-4 Using the Sound Recorder



### A. Recording Sound

1. Make sure you have connected the sound input device (e.g. microphone) to the computer.
2. To record the audio, click the **Start Recording** button .
3. To stop recording audio, click the **Stop Recording** button .

Be sure to save the recorded audio file upon completion.

### B. Playing the Recorded Sound

You can play your recording in a digital media player program that supports your audio file format.



## 6-2 Troubleshooting

### 6-2-1 Frequently Asked Questions

To read more FAQs for your motherboard, please go to the **Support & Downloads\FAQ** page on GIGABYTE's website.

Q: Why is the light of my keyboard/optical mouse still on after the computer shuts down?

A: Some motherboards provide a small amount of standby power after the computer shuts down and that's why the light is still on.

Q: How do I clear the CMOS values?

A: For motherboards that have a Clear CMOS button, press this button to clear the CMOS values (before doing this, please turn off the computer and unplug the power cord). For motherboards that have a Clear CMOS jumper, refer to the instructions in Chapter 1 to short the jumper to clear the CMOS values. If your board doesn't have this jumper/button, refer to the instructions on the motherboard battery in Chapter 1. You can temporarily remove the battery from the battery holder to stop supplying power to the CMOS, which will clear the CMOS values after about one minute.

Q: Why do I still get a weak sound even though I have turned my speaker to the maximum volume?

A: Make sure your speaker is equipped with an internal amplifier. If not, try a speaker with power/amplifier.

## 6-2-2 Troubleshooting Procedure

If you encounter any troubles during system startup, follow the troubleshooting procedure below to solve the problem.

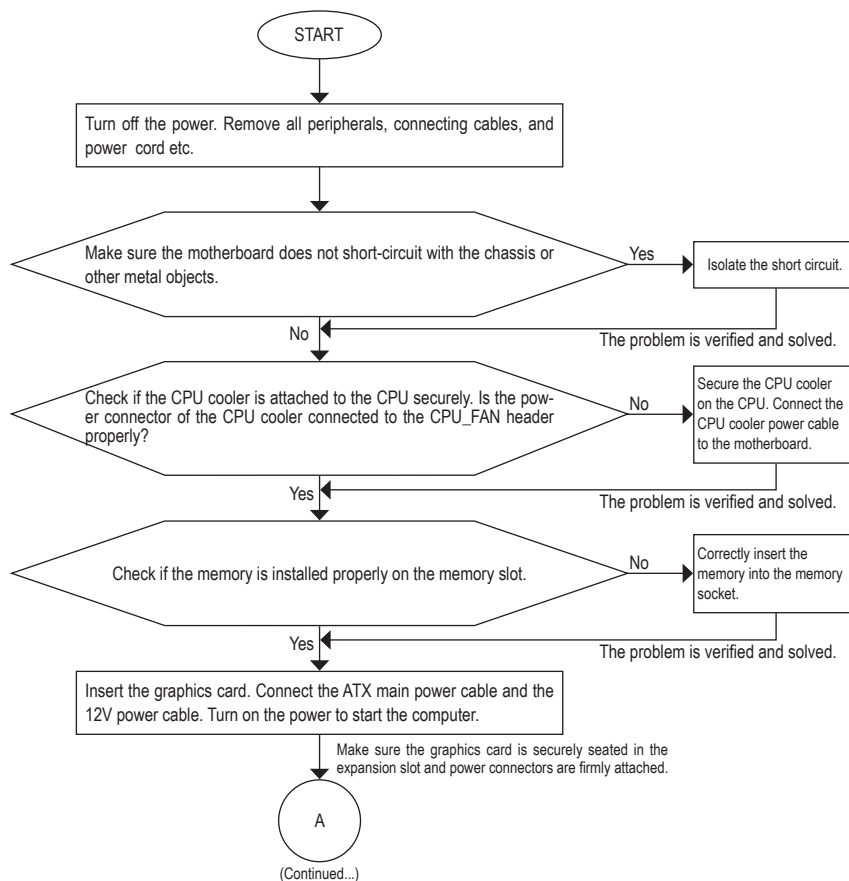

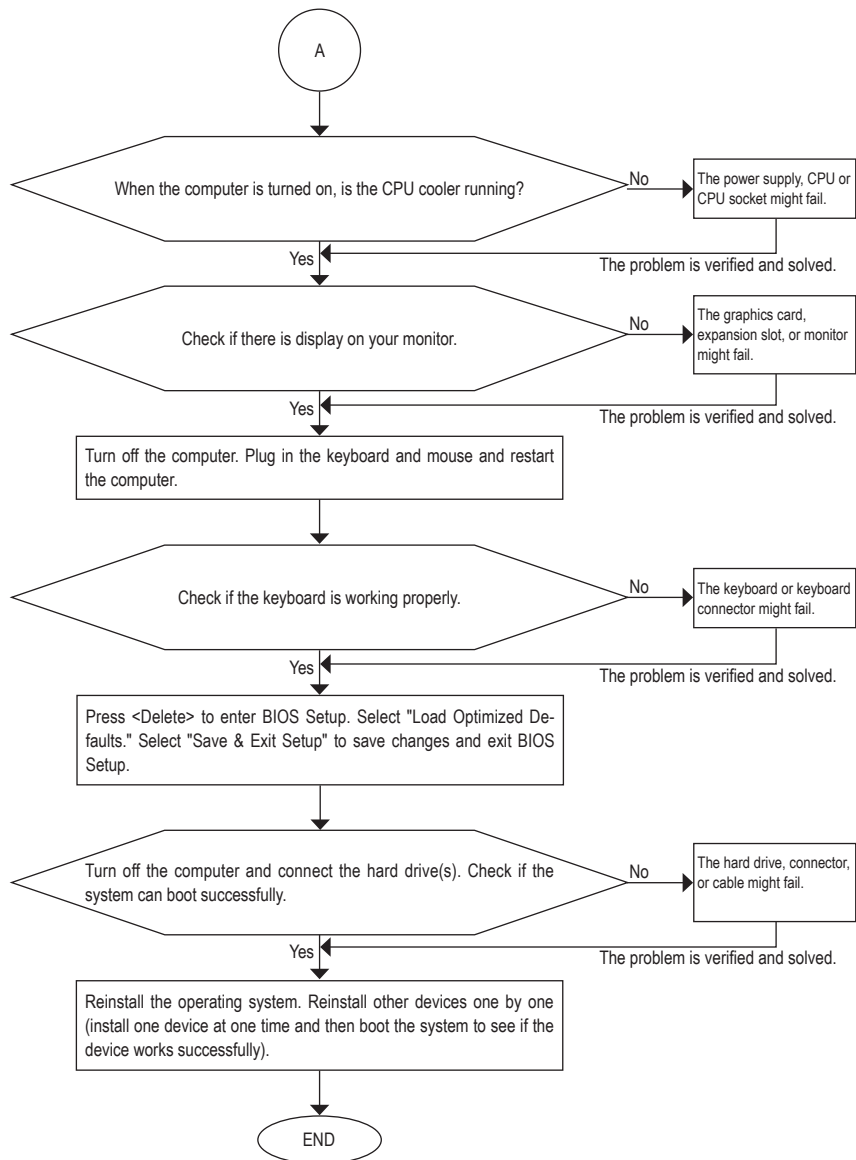

If the procedure above is unable to solve your problem, contact the place of purchase or local dealer for help. Or go to the **Support & Downloads\Technical Support** page to submit your question. Our customer service staff will reply you as soon as possible.

# Regulatory Statements

## Regulatory Notices

This document must not be copied without our written permission, and the contents there of must not be imparted to a third party nor be used for any unauthorized purpose. Contravention will be prosecuted. We believe that the information contained herein was accurate in all respects at the time of printing. GIGABYTE cannot, however, assume any responsibility for errors or omissions in this text. Also note that the information in this document is subject to change without notice and should not be construed as a commitment by GIGABYTE.

## Our Commitment to Preserving the Environment

In addition to high-efficiency performance, all GIGABYTE motherboards fulfill European Union regulations for RoHS (Restriction of Certain Hazardous Substances in Electrical and Electronic Equipment) and WEEE (Waste Electrical and Electronic Equipment) environmental directives, as well as most major worldwide safety requirements. To prevent releases of harmful substances into the environment and to maximize the use of our natural resources, GIGABYTE provides the following information on how you can responsibly recycle or reuse most of the materials in your "end of life" product.

## Restriction of Hazardous Substances (RoHS) Directive Statement

GIGABYTE products have not intended to add and safe from hazardous substances (Cd, Pb, Hg, Cr+6, PBDE and PBB). The parts and components have been carefully selected to meet RoHS requirement. Moreover, we at GIGABYTE are continuing our efforts to develop products that do not use internationally banned toxic chemicals.

## Waste Electrical & Electronic Equipment (WEEE) Directive Statement

GIGABYTE will fulfill the national laws as interpreted from the 2002/96/EC WEEE (Waste Electrical and Electronic Equipment) directive. The WEEE Directive specifies the treatment, collection, recycling and disposal of electric and electronic devices and their components. Under the Directive, used equipment must be marked, collected separately, and disposed of properly.

## WEEE Symbol Statement



The symbol shown below is on the product or on its packaging, which indicates that this product must not be disposed of with other waste. Instead, the device should be taken to the waste collection centers for activation of the treatment, collection, recycling and disposal procedure. The separate collection and recycling of your waste equipment at the time of disposal will help to conserve natural resources and ensure that it is recycled in a manner that protects human health and the environment.

For more information about where you can drop off your waste equipment for recycling, please contact your local government office, your household waste disposal service or where you purchased the product for details of environmentally safe recycling.

- ♦ When your electrical or electronic equipment is no longer useful to you, "take it back" to your local or regional waste collection administration for recycling.
- ♦ If you need further assistance in recycling, reusing in your "end of life" product, you may contact us at the Customer Care number listed in your product's user's manual and we will be glad to help you with your effort.

Finally, we suggest that you practice other environmentally friendly actions by understanding and using the energy-saving features of this product (where applicable), recycling the inner and outer packaging (including shipping containers) this product was delivered in, and by disposing of or recycling used batteries properly. With your help, we can reduce the amount of natural resources needed to produce electrical and electronic equipment, minimize the use of landfills for the disposal of "end of life" products, and generally improve our quality of life by ensuring that potentially hazardous substances are not released into the environment and are disposed of properly.







## Contact Us

---

**• GIGA-BYTE TECHNOLOGY CO., LTD.**

Address: No.6, Bao Chiang Road, Hsin-Tien Dist.,  
New Taipei City 231, Taiwan

TEL: +886-2-8912-4000

FAX: +886-2-8912-4005

Tech. and Non-Tech. Support (Sales/Marketing) :

<http://ggts.gigabyte.com.tw>

WEB address (English): <http://www.gigabyte.com>

WEB address (Chinese): <http://www.gigabyte.tw>

---

**• G.B.T. INC. - U.S.A.**

TEL: +1-626-854-9338

FAX: +1-626-854-9326

Tech. Support: <http://ggts.gigabyte.com.tw>

Warranty Info: <http://rma.gigabyte.us>

Web address: <http://www.gigabyte.us>

---

**• G.B.T. INC (USA) - Mexico**

Tel: +1-626-854-9338 x 215 (Soporte de habla hispano)

FAX: +1-626-854-9326

Correo: [soporte@gigabyte-usa.com](mailto:soporte@gigabyte-usa.com)

Tech. Support: <http://rma.gigabyte.us>

Web address: <http://latam.giga-byte.com>

---

**• Giga-Byte SINGAPORE PTE. LTD. - Singapore**

WEB address : <http://www.gigabyte.sg>

---

**• Thailand**

WEB address : <http://th.giga-byte.com>

---

**• Vietnam**

WEB address : <http://www.gigabyte.vn>

---

**• NINGBO G.B.T. TECH. TRADING CO., LTD. - China**

WEB address : <http://www.gigabyte.cn>

**Shanghai**

TEL: +86-21-63400912

FAX: +86-21-63400682

**Beijing**

TEL: +86-10-62102838

FAX: +86-10-62102848

**Wuhan**

TEL: +86-27-87685981

FAX: +86-27-87579461

**GuangZhou**

TEL: +86-20-87540700

FAX: +86-20-87544306

**Chengdu**

TEL: +86-28-85483135

FAX: +86-28-85256822

**Xian**

TEL: +86-29-85531943

FAX: +86-29-85510930

**Shenyang**

TEL: +86-24-83992342

FAX: +86-24-83992102

---

**• GIGABYTE TECHNOLOGY (INDIA) LIMITED - India**

WEB address : <http://www.gigabyte.in>

---

**• Saudi Arabia**

WEB address : <http://www.gigabyte.com.sa>

---

**• Gigabyte Technology Pty. Ltd. - Australia**

WEB address : <http://www.gigabyte.com.au>

- **G.B.T. TECHNOLOGY TRADING GMBH - Germany**  
WEB address : <http://www.gigabyte.de>

---

- **G.B.T. TECH. CO., LTD. - U.K.**  
WEB address : <http://www.giga-byte.co.uk>

---

- **Giga-Byte Technology B.V. - The Netherlands**  
WEB address : <http://www.giga-byte.nl>

---

- **GIGABYTE TECHNOLOGY FRANCE - France**  
WEB address : <http://www.gigabyte.fr>

---

- **Sweden**  
WEB address : <http://www.gigabyte.se>

---

- **Italy**  
WEB address : <http://www.giga-byte.it>

---

- **Spain**  
WEB address : <http://www.giga-byte.es>

---

- **Greece**  
WEB address : <http://www.gigabyte.com.gr>

---

- **Czech Republic**  
WEB address : <http://www.gigabyte.cz>

---

- **Hungary**  
WEB address : <http://www.giga-byte.hu>

---

- **Turkey**  
WEB address : <http://www.gigabyte.com.tr>

---

- **Russia**  
WEB address : <http://www.gigabyte.ru>

---

- **Poland**  
WEB address : <http://www.gigabyte.pl>

---

- **Ukraine**  
WEB address : <http://www.gigabyte.ua>

---

- **Romania**  
WEB address : <http://www.gigabyte.com.ro>

---

- **Serbia**  
WEB address : <http://www.gigabyte.co.rs>

---

- **Kazakhstan**  
WEB address : <http://www.gigabyte.kz>

---

You may go to the GIGABYTE website, select your language in the language list on the top right corner of the website.

- **GIGABYTE Global Service System**

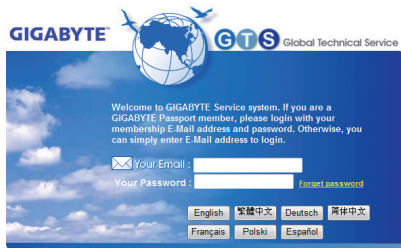

To submit a technical or non-technical (Sales/Marketing) question, please link to:

<http://ggts.gigabyte.com.tw>

Then select your language to enter the system.